

REGISTRATION STARTS HERE

Please also refer to the current version of the Accreditation Process document on the SGLD website

2024

Membership of the Society of Garden + Landscape Designers

- Registered Members
- Registered Practices
- Pre-Registered Members
- Student Members
- Friends
- Business Affiliate

All Fellows, Registered and Pre-Registered Members must hold current PI Insurance and any other insurance relevant to cover all your business activities.

All Members of the Society are bound by the Society's Code of Professional Conduct and Good Practice. This can be downloaded from the SGLD website www.SGLD.org.uk

The route to Registered Membership

There are two routes to Registered Membership:

- **Single submission** - Present 3 projects at once
- **Multiple submission** - Present each project individually.

For each accreditation, there will be a panel of 3 Registered Members or Fellow Members who form part of the accreditation committee.

You are not required to attend the accreditation in person, but you will be required to be available via telephone should the panel wish to contact you about any element of your submission on the date of accreditation.

Feedback and results from your accreditation submission will be sent via email up to 21 days after the date of accreditation. The results can be either:

- **ACCEPT** – Completion of all components of a project to an acceptable level of professional competence.
- **REFER** – Submission does not demonstrate an acceptable level of professional competence in at least one component of a project or does not complete at least one component of a project.
- **NOT TO REQUIRED STANDARD** – Submission does not demonstrate competence in the majority of a project's components

Submitting projects

- All plans must be to an appropriate and recognised scale so that sizes can be checked with a scale rule during accreditation.
- Plans should not be reduced and should be printed out to scale with a scale bar and paper size indicated on each plan.
- For example: Presentation plan: 1:50, 1:100, 1:200
- Construction drawings: 1:10 or 1:20
- Planting plans: 1:50 or 1:100
- The only hard copies required for the accreditation are of your presentation plan and your planting plan which should be printed to scale and sent to the SGLD Chair of Accreditations by the submission date. To reduce the environmental impact, we ask that when you send in your hard copies, please send in A4 paper copies (or folded to A4 size), no plastic folders, cardboard folders, or wallets are required. **It is important that the hard copy submission fits into a paper A4 envelope.**

Projects for submission

For each of your three projects you must include the following:

1. CV (only submit once if doing a single submission)
2. Agreed Client Brief
3. Client-Designer Contract Documentation
4. Site Survey
5. Site Analysis
6. Design Rationale
7. Presentation Plan, cross section, suitable to be submitted to the client.
8. Planting Plan(s)
9. Plant Schedule
10. Setting Out Plan(s)
11. Construction Details – *a minimum of TWO of the most significant features*
12. Specification document to contractor
13. Management and Development Plan with Sustainability Statement (**third project only**)
14. CDM Risk Assessment (**third project only**)
15. Photographic Record – *before and after completion, and during construction for projects that have been monitored*

Supporting portfolio

This is **optional** and must be submitted via Dropbox only and clearly labelled or provide a link to the portfolio section of your website.

- A maximum of six pieces of work selected to show the range of your abilities.
- May include show gardens.
- May include drawings, plans, models and photographs.
- May include website address.

SOCIETY OF
GARDEN +
LANDSCAPE
DESIGNERS

The following slides give one or more examples of each of the requirements for accreditation.

Slides showing plans are sometimes at a low resolution to protect the copyright of the people who produced them.

As a designer you will develop your own style, but the presentation gives guidelines on what must be included on your plans and the clarity of instruction to a Landscape Contractor.

2. Agreed Client Brief

This is your record of the client's requirements, which should include:

- Practical needs and constraints
- Problems to be addressed
- Existing features to be incorporated
- New features desired and new opportunities
- Aesthetic preferences, mood and style
- Planting preferences
- Maintenance considerations
- Budget available

2. Agreed Client Brief – example

LANDSCAPE DESIGN BRIEF FOR THE KITCHEN GARDEN

- Restore the walled kitchen garden by creating areas to grow produce, as well as ornamental areas in keeping with the kitchen garden theme. Include structures and archways to define areas, provide focal points, vistas and frame views
- Maintain the open aspect of the garden
- To include cut flower beds, a herb area, fruit bushes and trees
- To include a seating area as well as occasional seats around the garden. The views from the house windows are important and the arrangement of the garden needs to make best use of this
- Look at the area overlooked by the kitchen and add purpose to a currently bland area
- The area between the greenhouse and wood store, which is currently being used to grow herbs, requires enhancing and linking with the rest of the garden
- Replace the greenhouse
- Overall budget agreed not to exceed £XXXX

Please can you sign below and add comments if required:

Signed:	
Comments:	

3. Client-Designer Contract Documentation

- Include your quotation and payment schedule (you do not have to show actual amounts, but can do so if you would like feedback on fee scale)
- Include your terms of engagement
- May include tender documentation
- May include details of site visits and project monitoring
- Include confirmation from client to proceed
- Do not include personal detail of client in submission
- May include fee amounts

Proposal – example

(Insert date)

Dear (insert client name),

GARDEN DESIGN – FEE PROPOSAL

It was good to meet up with you on Saturday. As promised, I have outlined below a quotation for the design work we discussed.

- **Topographical Survey**
To undertake a survey of the back garden and side of the house. This involves measuring all the existing features, the changes in level, boundaries, etc. This provides a base plan for the design.
- **Sketch Designs**
To complete two sketch designs for discussion. This shows the initial design proposals and ideas, before the detailed master plan is produced.
- **Master plan**
To complete a detailed master plan, incorporating any changes required. This will illustrate the overall layout showing the structures, paved areas, changes in level, the type of materials to be used and the planted areas (but is not a detailed planting plan).

Total = £XXX

Please can you confirm in writing if you would like to proceed and agree to our terms and conditions attached. If you have any queries, please do not hesitate to contact me.

I look forward to hearing from you and working on your garden.

Yours sincerely,

Fee Proposal – example

GARDEN CONSTRUCTION – FEE PROPOSAL

After our meeting on Friday, I have outlined below the fees as requested for the following:

- **Working Drawings and Specifications**

To produce working drawings and specifications for all phases of the project to enable it to be constructed. This includes the following:

- Bill of quantities
- Specification
- Setting out / Layout plan
- Pergola detail
- Retaining wall and step detail

Total = £XXX

- **Tender documents**

To produce and send the necessary tender documents and conditions of the contract to 3 contractors to prepare their tender.

Total = £XXX

- **Implementation**

Award and prepare the contract for the required external landscape work.

The contract is a standard form of contract between Client and Contractor and is prepared to protect the interests of both parties.

A minimum of 2 site visits will be made per week of construction to inspect the construction work and check that the necessary progress and quality is being achieved. I will keep you informed of progress throughout the job.

Periodic Certificates of Payment will be issued of amounts due to the contractor and inspections will be conducted to establish final completion and ensure a satisfactory conclusion to the project for all parties.

Total = £XXX

NB All printing costs are additional and at cost

**SOCIETY OF
GARDEN +
LANDSCAPE
DESIGNERS**

Please can you confirm in writing if you would like to proceed and agree to our terms and conditions attached. If you have any queries, please do not hesitate to contact me.

I look forward to hearing from you and working on your garden.

Price for site visits – example

On previous projects, we have agreed a percentage on top of the landscaper's quotation to monitor the build with regular visits. However, due to the build value and the confidence that Anthony is very competent and will only require minimum input from us, may I suggest that we agree a set of figures to call once a fortnight to check progress etc.

In addition to this you could call us to the site should you feel the need at any time (subject to our availability). Our fees for these visits would be:

- To visit site on commencement of build to liaise and set out with the landscaper - £XXX
- To visit and spend an hour on site once a fortnight to check progress of work - £XXX
- For additional visits of up to an hour requested by client or landscape (with agreement from client) - £XXX
- Additional time spent on site over an hour or part of an hour will be charged at - £XXX

We will email you daily with any costs incurred from visits and raise an invoice on a weekly basis with payment becoming due by return.

I trust that this is acceptable to you and look forward to seeing the garden develop over the next few months.

Designer-client contract & terms of engagement

- The SGLD has produced a consultancy agreement for a domestic customer to appoint a garden designer to design and, if required, to monitor the construction and planting of the garden or advise the customer whilst the customer deals directly with a landscape contractor constructing the garden.
- The JCLI documents are regularly updated. Please ensure that you are using the current version.
- The JCLI documents can be purchased from the SGLD shop on the website <https://www.SGLD.org.uk/members/shop/> and template terms of engagement can be found on the SGLD's website under members area > resource area > general



JCLI Design Consultancy Agreement for a Home Owner/Occupier

4. Site Survey

The record of the site as existing, including:

- Boundaries, location & context
- Buildings including windows, doors and access
- Trees, their canopies and trunk diameter, root protection area (RPA)
- Off-site features such as trees, RPA or buildings that affect the site
- Levels – even if ‘flat’ including DPC levels and base of trees, walls, etc.
- North point, scale and paper size, scale bar
- Include Title block preferably to lower right- hand side corner with notes section above
- Orientate page to Landscape

4. Site Survey – example

The following slides zoom in on various areas of the survey drawing

- Note the way the levels are shown
- The datum point – suggested as sill, FFL or DPC
- The clearly marked building showing doors and windows
- Existing trees should be shown with spot levels to their base
- Clear annotation of all existing features

4. Site Survey – colour example of professional survey



4. Site Survey – monochrome example of professional survey

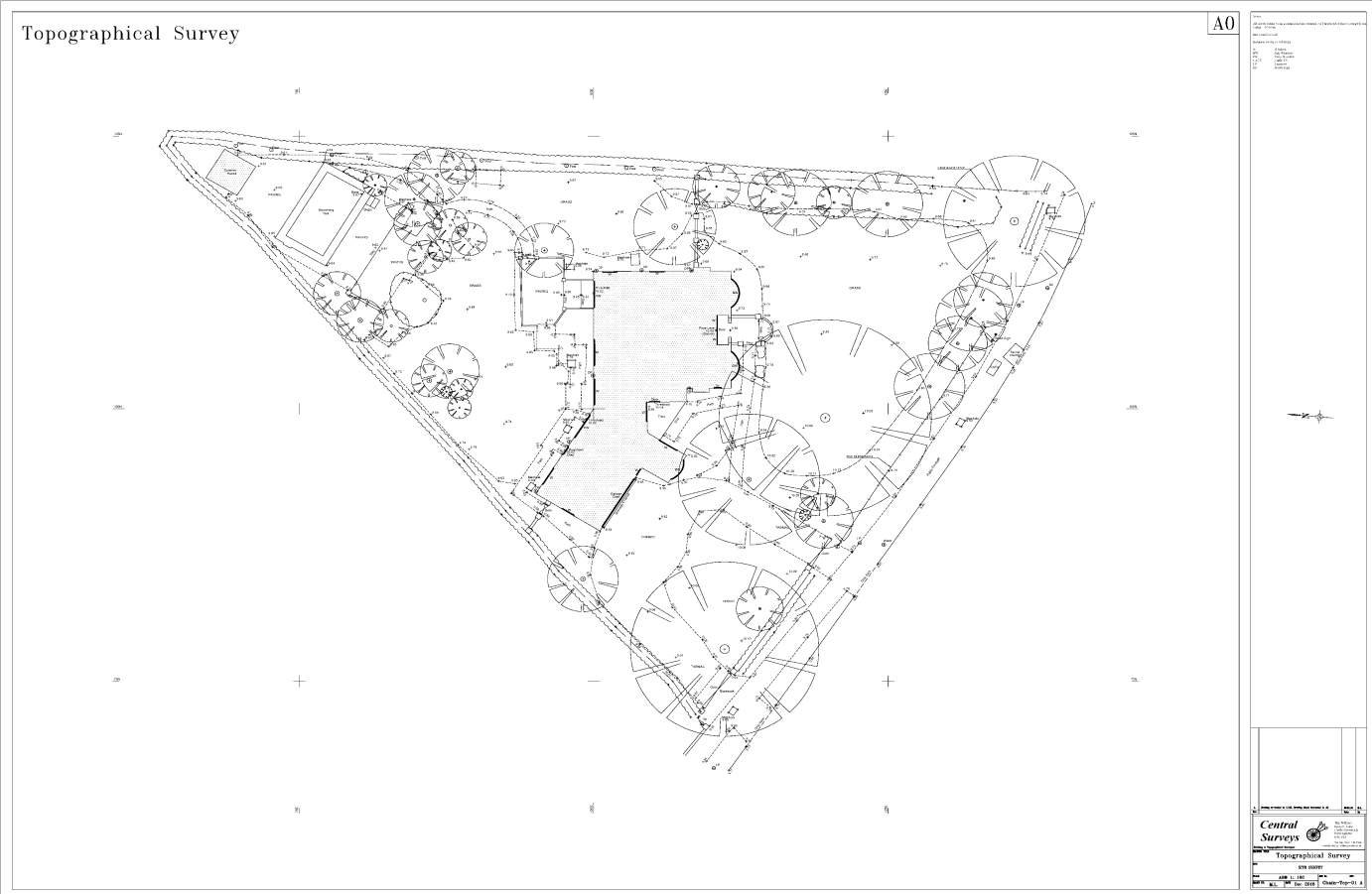

4. Site Survey - section of professional survey

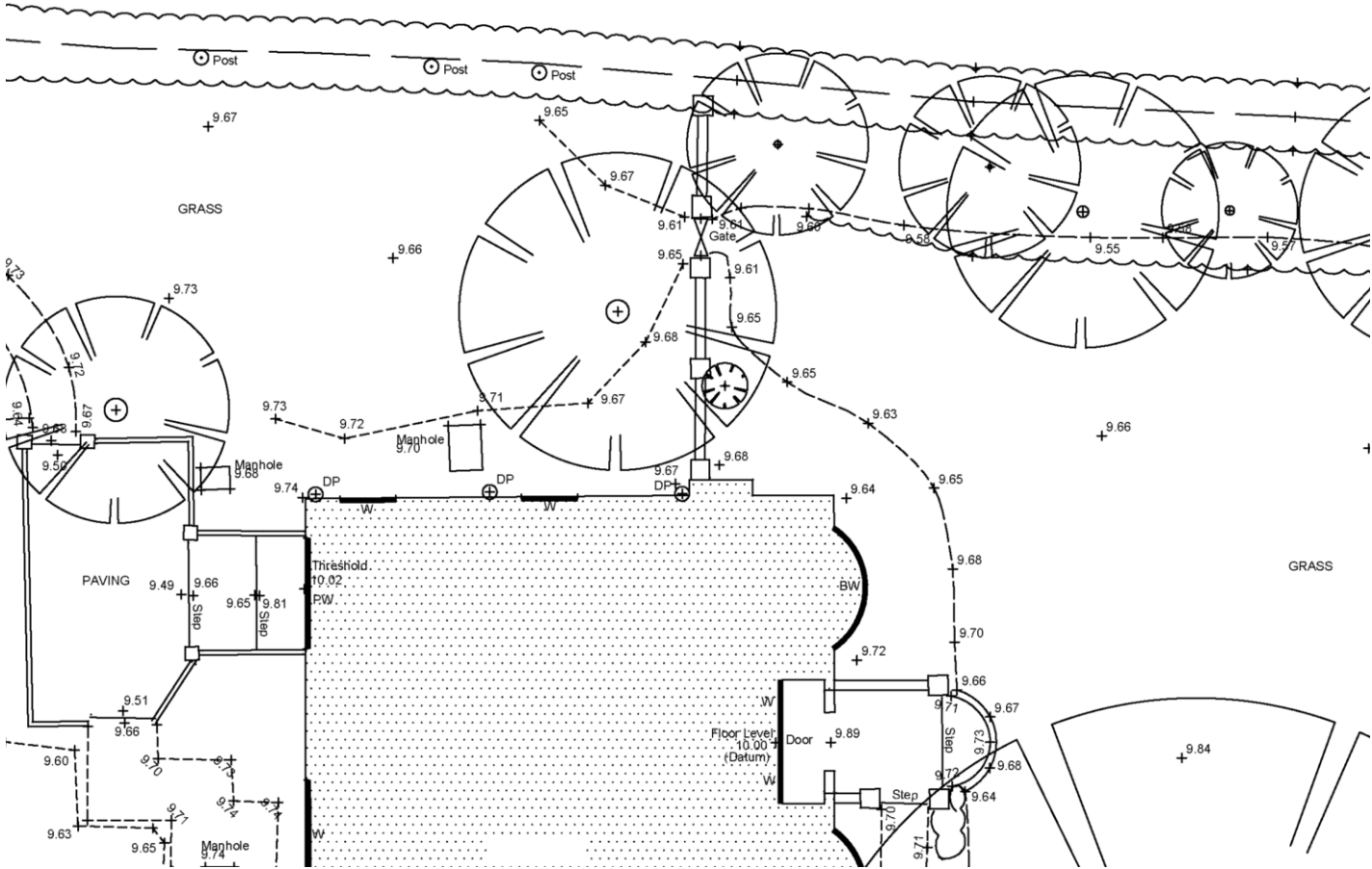

4. Site Survey – example key & title box

LINETYPES & SYMBOLS	
	BUILDING OUTLINE
	KERB LINE
	FENCE
	SURFACE EDGE
	FOUL DRAINAGE
	STORM DRAINAGE
	GAS PIPES
	WATER SERVICE PIPES
	BRITISH TELECOM CABLES
	ELECTRICITY CABLES
	OVERHEAD CABLES
	FOLIAGE OUTLINE
	SURVEY STATION
	GATES
	TREE CANOPY
	SLOPE SYMBOL

LEGEND			
AV	AIR VALVE	HP	NAME PLATE
B	BOLLARD	OB	OPEN BARRIERS FENCE
BB	BELISHA BEACON	OF	OPEN PALING FENCE
BM	BUS STOP	PC	POST & CHAIN FENCE
BTB	BRITISH TELECOM BOX	PCB	POLICE CALL BOX
BF	BURB WIRE FENCE	PH	PUBLIC HOUSE
CB	CLIQUE BOARD FENCE	PL	PARKING LIGHT
CH	COAL HOLE	PM	PARKING METER
CHY	CHIMNEY	PS	POST & RAIL FENCE
CL	CHAIN LINK FENCE	PM	POST & WIRE FENCE
CM	CELLAR MANHOLE	RE	POST & WIRE MESH
CP	CEMENT PALING FENCE	RS	ROOFING EYE
CTV	CABLE TELEVISION POINT	RTW	ROAD SIGN
DC	DRAINAGE CHANNEL	SP	SEWER INDICATOR POST
DK	DROP KERB	SV	STOP VALVE
ELC SUB	ELECTRICITY SUB	TBB	TELEPHONE CALL BOX
STN	STATION	TP	TOP OF WALL
SP	ELECTRICITY POLE	TS	TRAFFIC SIGNAL
FB	FOOT BRIDGE	UTL	UNABLE TO LIFT
FE	FIRE ESCAPE	VP	VENT PIPE
FN	FIRE HYDRANT	WM	WASTE BIN
FP	FOOTPATH	WM	WATER METER
FS	FLAGSTAFF	WO	WASH OUT
G	GULLY		
GR	GRATING		
GV	GAS VALVE		
H	HYDRANT		
IC	INSPECTION COVER		
I	INVERT LEVEL		
R	IRON RAILINGS		
KO	KERB OUTLET (GULLY)		
LP	LAMP POST		
LB	LETTER BOX		
MCC	MIXED CONSTRUCTION FENCE		
MH	MANHOLE		
MST	BRITISH TELECOM		
M-E	ELECTRICAL		
M-C	GAS		
M-M	METREY		
M-P	MILE POST		
NB	NOTICE BOARD		

NORTH (INDICATIVE)

	LAND & MEASURED BUILDING SURVEYORS M.J.ZARA ASSOCIATES	139 HIGH STREET – LEWES EAST SUSSEX – BN7 1XS TEL. 01273 472492 E-MAIL: mizarassociates@gmail.com
--	---	--

SITE

CLIENT

NOTES
 LEVELS BASED ON ARBITRARY DATUM LOCATED ON SURVEY STATION No.2
 VALUE 20.00m
 CONTOURS ARE COMPUTER GENERATED.
 .IOR RFF RR79

Detail showing the notes on a survey. In particular note the reference to the Datum point.

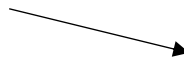

4. Site Survey – example

Detail showing how doors and windows are displayed in the building and how levels are shown

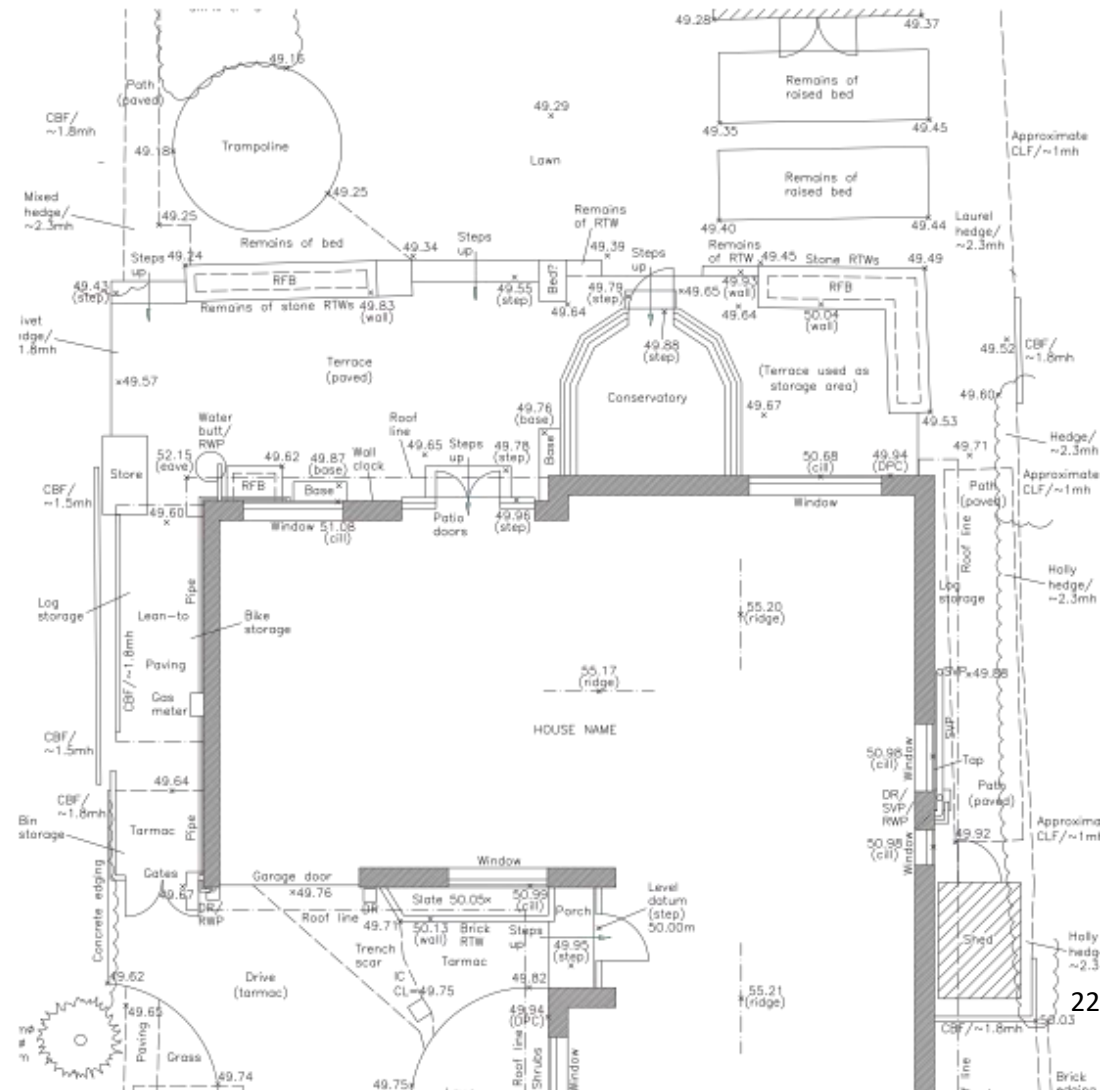

4. Site Survey – example

Survey drawing for a small garden,
 drawn up by the designer.

Ideally the plan should be orientated
 with North to top of page.

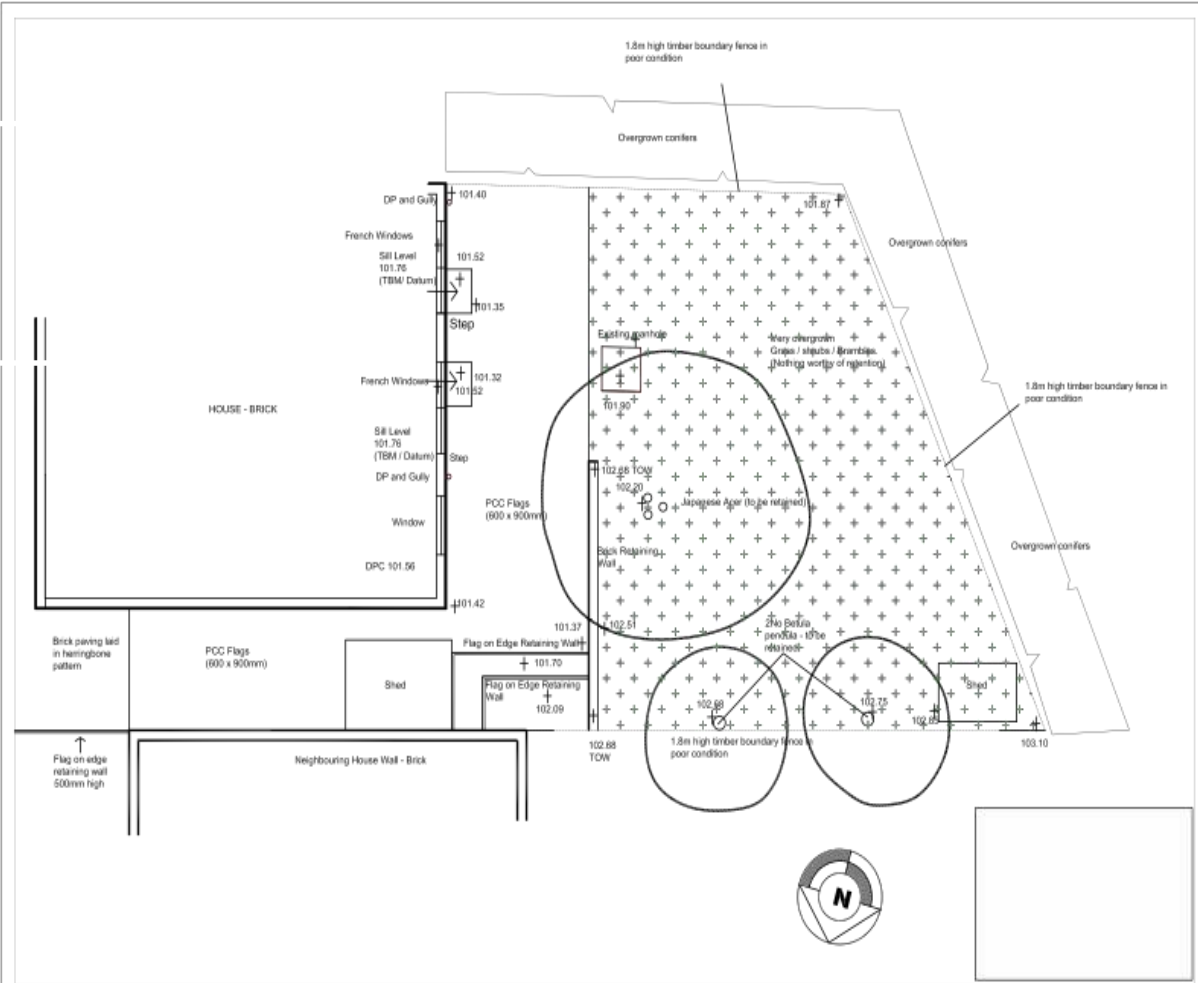

4. Site Survey – example

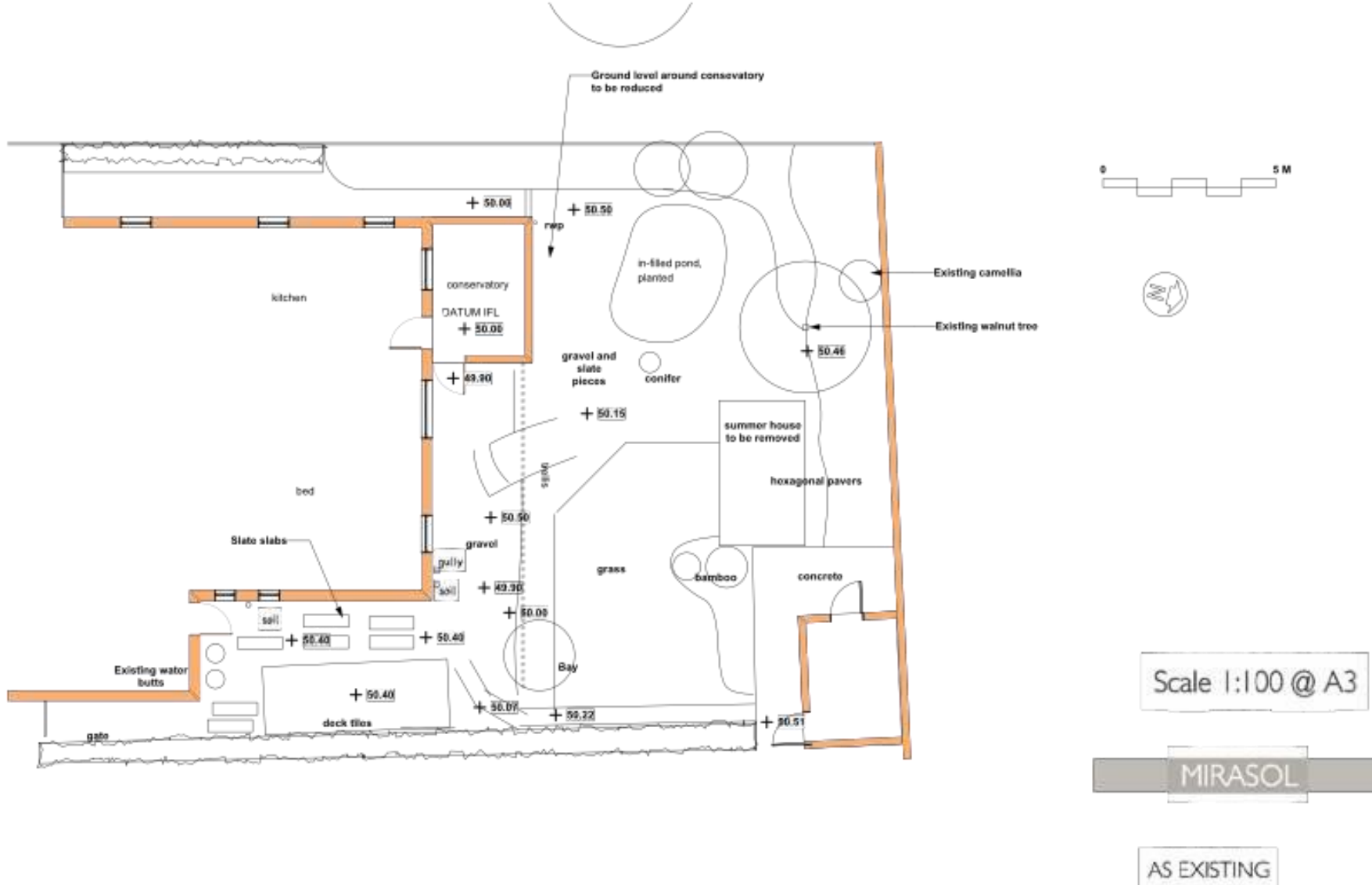

5. Site Analysis

Your observations about the site which may affect the design, such as:

- Planning and statutory constraints: TPO's, listed buildings, conservation areas, rare or protected species etc.
- Good and bad views
- Sun and shade
- Prevailing wind
- Geology and soil type e.g. structure, acidity, etc.
- Drainage problems or boggy areas
- Boundary issues
- Your first impressions of the area and how these fit in with your initial thoughts on the design

5. Site Analysis Plan – example

Additional notes in red have been added to the survey drawing.

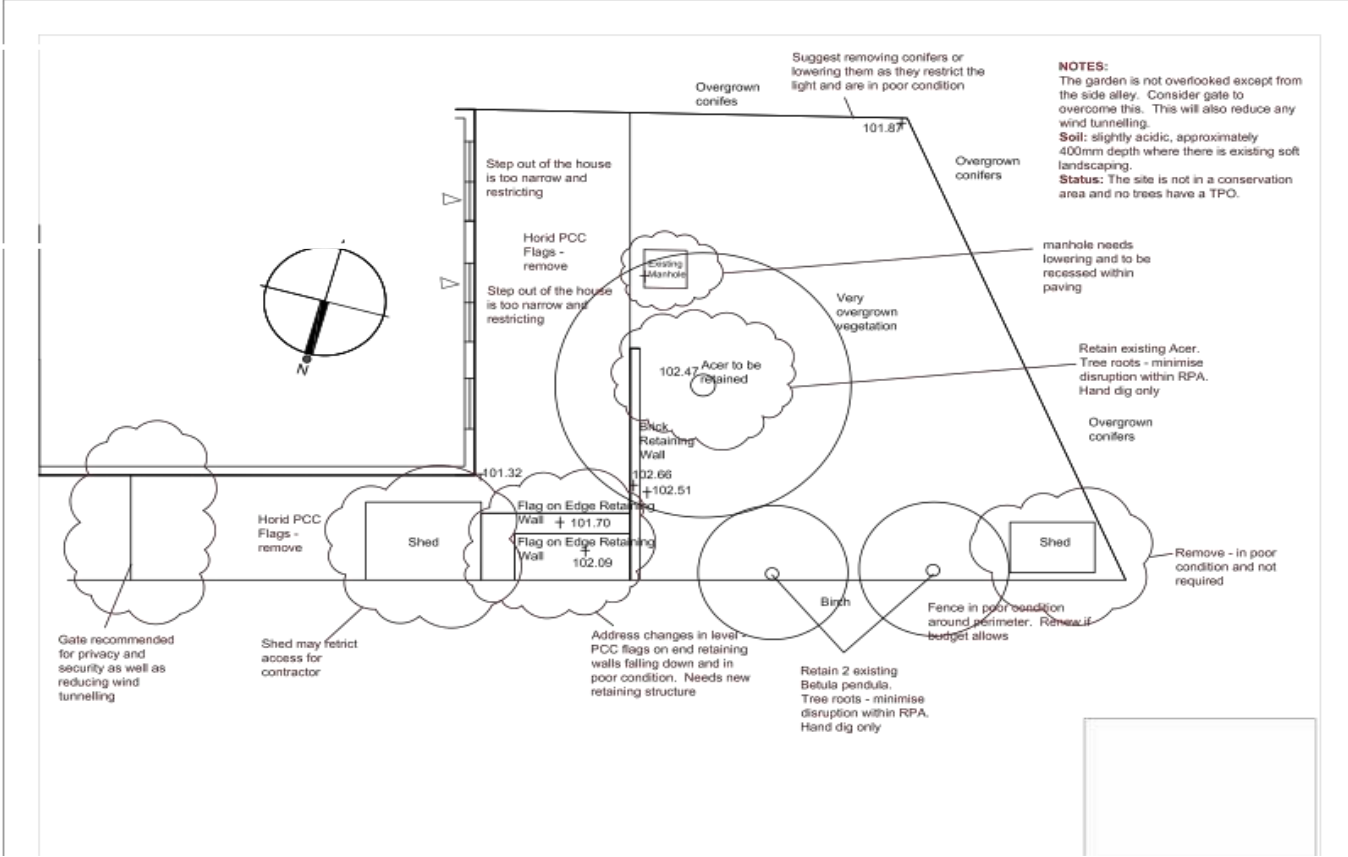

5. Site Analysis Plan – example

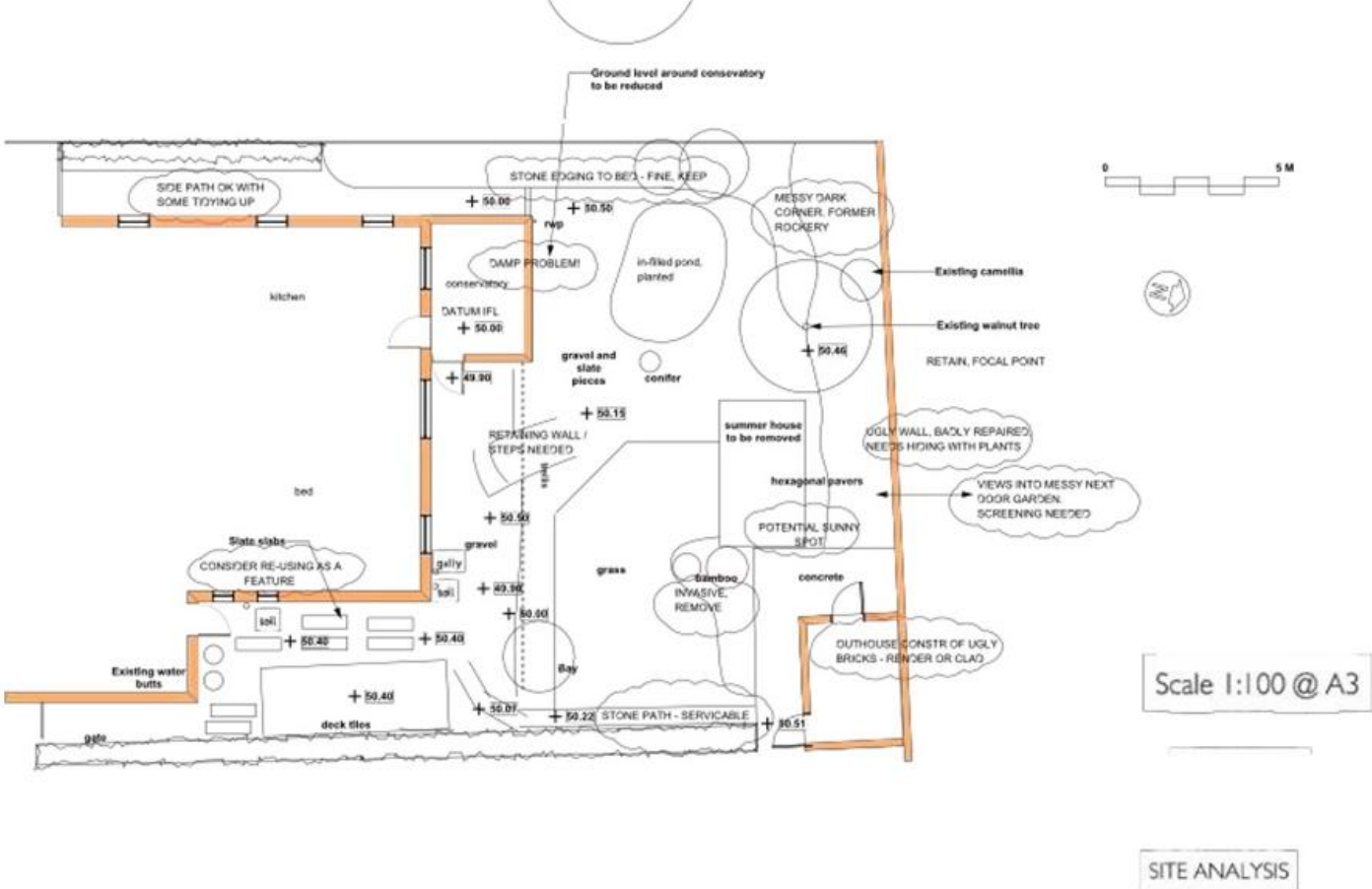

5. Site Analysis Plan – example

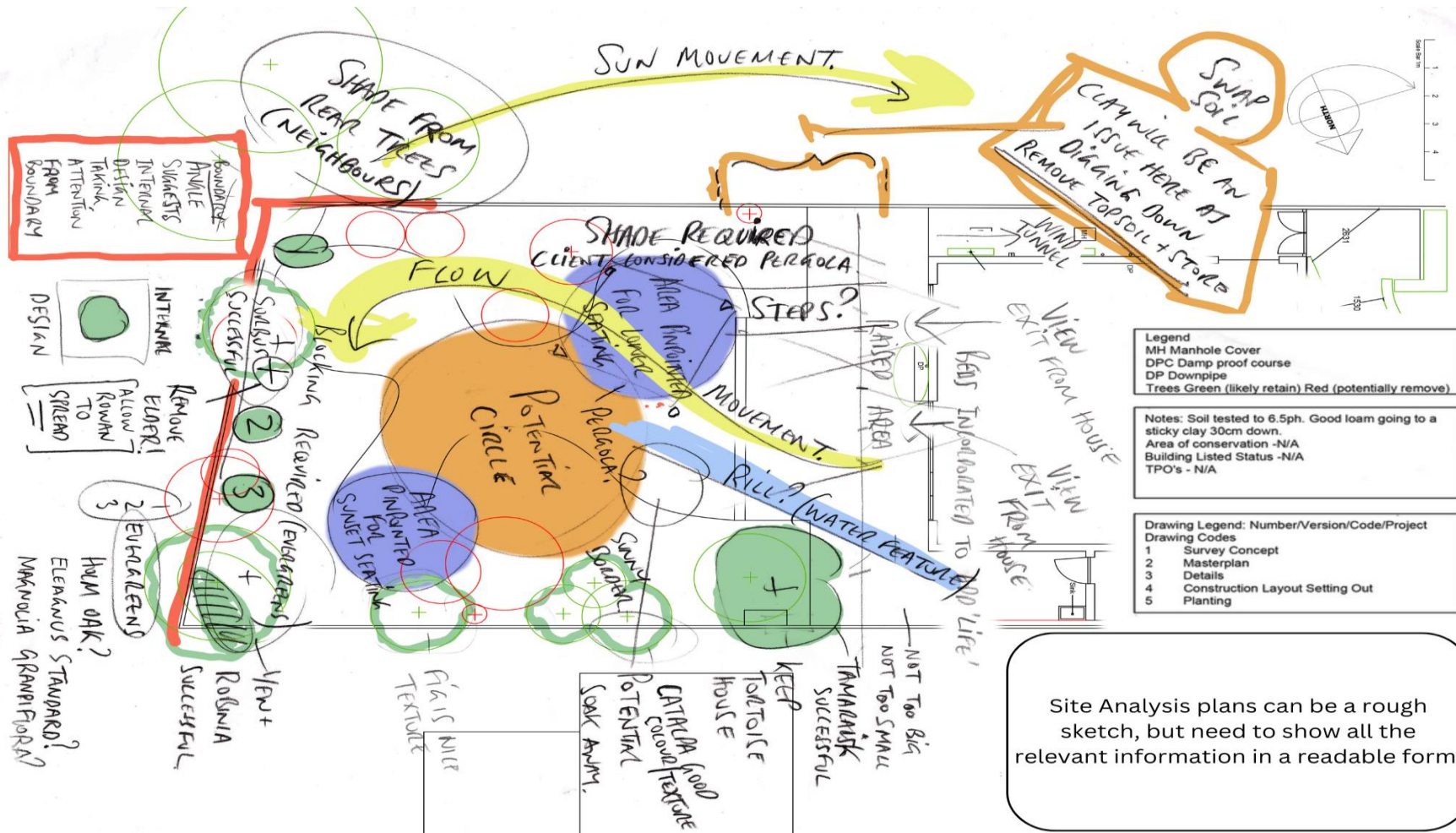

5. Site Analysis as written notes – example

Site Analysis plans can be a rough sketch, but need to show all the relevant information in a readable form.

SOCIETY OF GARDEN + LANDSCAPE DESIGNERS

- Existing walnut tree provides a focus and some screening value – keep
- Silver birch tree next door adds useful height without impinging on the space
- Brick wall 1.2m high forming north boundary is ugly and ineptly repaired – reinstate or disguise
- 2m privet hedge on east is fine, needs trimming and feeding
- 1.8m panel fence on south boundary is fine
- Existing paths on the west side of the house and along the hedge on the east side are serviceable and could be kept
- Internally the garden can be treated as a 'blank canvas'. Summer house to be removed
- Former pond, now converted to a planting bed: extent of buried concrete construction unknown and needs investigating. Existing brick shed to stay and be made more attractive – perhaps rendered or timber clad. There is existing power and lighting in the shed – needs to be checked and updated
- Invasive bamboo shoots will need digging out
- Ground level inside the conservatory has been raised in the past and is causing damp problems
- There are seven rectangular pieces of cut slate (1200 x 300 x 25) which could be reused in some way
- Soil is sandy loam, free draining, slightly acidic.

5. Site Analysis as written notes – example (cont.)

SOCIETY OF
GARDEN +
LANDSCAPE
DESIGNERS

- No TPO's or listing, not a conservation area. Access to garden from parking area through side gate (90cm wide)
- Exposed to North. Average rainfall 614mm. Max/min temperature....

6. Design Rationale

SOCIETY OF GARDEN + LANDSCAPE DESIGNERS

WHAT is the basis for the design and what are its objectives?

- An explanation of the design objectives relative to the brief, the site and the existing architecture where appropriate.

WHY is it appropriate for this client, brief and site?

- An explanation of the thinking behind the design, whether concept-driven or otherwise, and why it is appropriate for this project.

HOW have your design objectives been achieved?

- An explanation of how the objectives have been achieved through spatial design, use of materials, and planting.

It may be relevant to include how the management, future sustainability and environmental impact of the project have been considered at the design stage.

This rationale clearly sets out the basis for the design - what was needed - and goes on to describe how the design addresses those issues:

The main driver for the design was to address a steep and badly planted section of the garden, creating a more visually appealing feature that is incorporated into the rest of the garden and its flow. The design also needed to address the overly exposed sunny rear elevation of the house by creating much needed dappled shade for the ground floor windows. The newly crafted spaces need to take advantage of the internal and external views alongside making the most of the sun and shade.

SOCIETY OF GARDEN + LANDSCAPE DESIGNERS

... a feature set of steps lead you up and out of the garden. This set of steps is not only a functional feature, granting year-round access to the side gate, but helps to break up the mass and dominance of the bank. Surrounded by planting on all sides the new steps allow the bank to be regraded to soften the gradient to further reduce the impact of the bank. At the top of the first section of steps a new tree has been planted to create a long focal view across the rear of the house.

...The main terrace and view out is framed by industrial steel beams that form a climbing frame for plants, framing the view out of the kitchen to the wider landscape with planting on ground level being brought right into the house on both sides. The wires and climbing plants not only gently frame the view out but give a sense of enclosure and privacy from the neighbours to the side. A feature tree sits off to one side to create much needed dappled shade and creates another framed view from the window of the dining area.

The planting throughout the garden is designed on multiple levels. First and foremost, the planting is about diversity, bringing in a wider selection of plants to enhance the biodiversity of the garden. Beyond that the bold structural feature plants and blocks of clipped topiary form the backbone of the garden, giving much needed height, shade and textural contrast to an overlaid planting scheme that is softer, grass and shrub based, echoing the wider landscape, helping to bring the wider landscape into the garden.

Rationale for a contemporary and sculptural design:

The clients needed a practical and functional space, but also a garden that had a sense of intrigue and discovery ... something ... playful and elegant.

The new design zoned the garden into usable 'rooms' [as] the long thin shape could have felt like a corridor without careful planning and design to create places to stop and pause. It was clear the clients had pretty radical taste with their very modern extension and huge guillotine doors, so the cubist landscape design was in response to this radical architectural feature.

SOCIETY OF GARDEN + LANDSCAPE DESIGNERS

... The 'cubist cliff-path' that playfully moved from basement to ground floor level through a bank of lush planting, and over cascading water features gave them the bold, modern and playful design they were looking for. This design language continued into the upper garden, with the majority of seating built in for space saving in the narrow garden, and to harmonise with the landscaping.

Concrete was chosen as the hard landscape material for its fluid properties, and ability to be pumped (rather than carried) down the narrow side return.

Lush planting and characterful trees, to create intrigue and a sense of discovery added to the atmosphere of the space.

Rationale for a restrained, traditional design:

A site sensitive, 'light touch' with a strong sense of place, respectful of the history of the house and garden.

The proposals are led by the Georgian architecture and the overall scheme by [the architects] seeking to reuse and enhance what is already there.

SOCIETY OF GARDEN + LANDSCAPE DESIGNERS

Retaining existing trees, repurposing the existing York stone paving, working with the existing brick boundary walls whilst creating a generous lawn for kicking around with a ball, an uplifting 'journey' from the house to the new garden building, a beautiful outlook from the refurbished interiors and a series of inspiring, useable spaces to sit, play, relax and entertain.

A generous, central pathway of large format York stone with lime mortar softened by overspilling woodland planting randomly punctuated by yew domes links to the classical proportions of the house without being overly formal. Three multistemmed *Prunus yedoensis* line the pathway. Their blossom peak is designed to coincide with the existing magnolias. Together they create an incredible 'moment' in early spring when the clients are using the house.

Rationale for the design of an awkwardly sloping site:

The aim of the design was to transform the unattractive, underused, steeply sloping garden to the rear and sides ... Flow was to be provided round the garden, making the garden useable. The plants were to be on the lower end of the maintenance scale, suitable for site and conditions, and to be attractive to a range of wildlife.

Access from the kitchen and conservatory to a large deck for dining has been much improved, offering an attractive view from the conservatory and invites the family into the garden. Paths, terracing and steps link the gardens, forming a wrap-around garden that

SOCIETY OF **GARDEN +** **LANDSCAPE** **DESIGNERS**

connects the front, back and sides of the garden. From the terraces, steps meander down the plant-covered hill to paths that run along the contours breaking up the descent and offering places to pause.

Whilst the garden has mostly worked with the slope, a level area has been created at the top of the garden where views can be enjoyed and the children can play ...

Whilst working with the slope of the garden, the design encourages greater use and enjoyment of the whole garden, creating a garden that is relatively easier to maintain and is good for wildlife.

7. Presentation Plan

The presentation plan is the main drawing that you present to your client to communicate and 'sell' your ideas. It should be clear, accurate, and easy to understand. It is your opportunity to display your skill as a designer in response to the demands and constraints of the site and the brief.

In addition to the 2D plan, at least one cross-section should be included with the Presentation Plan to clearly demonstrate the mass and void of a design, and how any changes in level have been dealt with. For sites with complex level changes more than one cross-section may be appropriate.

- Hand drawn or CAD
- Include North point
- State scale and paper size and include a scale bar
- Use clear and accurate graphics
- Communicate changes of level and heights of structures using clear graphics and annotations. Include cross-section on drawing
- Show areas of hard landscaping and planting, indicating their general character without too much distracting detail
- Differentiate existing and proposed trees
- Show spot levels

7. Presentation Plan – example

Please see Site Analysis Plan on page 28

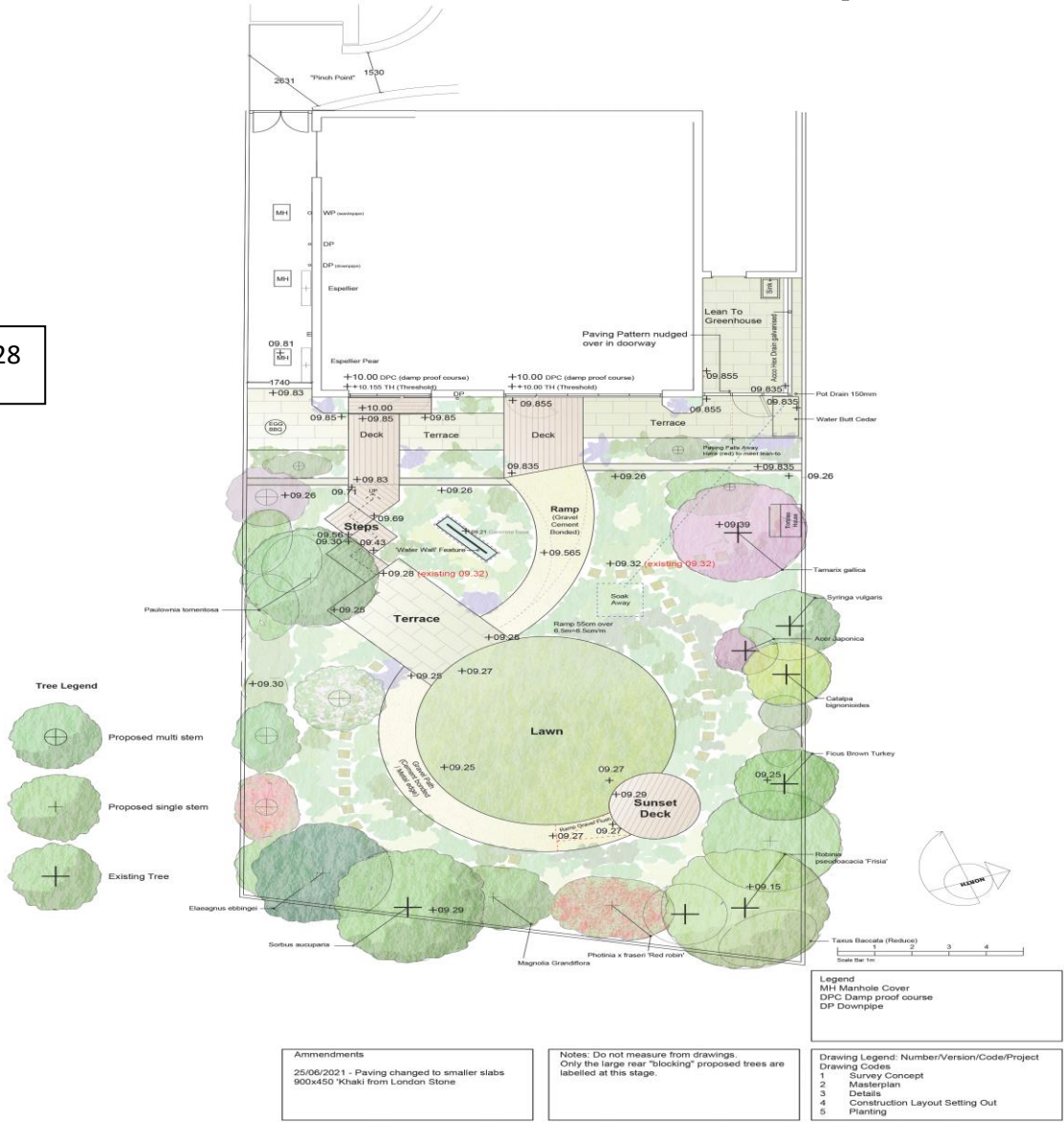

7. Presentation Plan – example



7. Presentation Plan – example

Part of a simple presentation plan submitted in black and white. It has been copiously labelled to explain the different components, levels are clearly marked and the DPC is highlighted as datum for the levels.

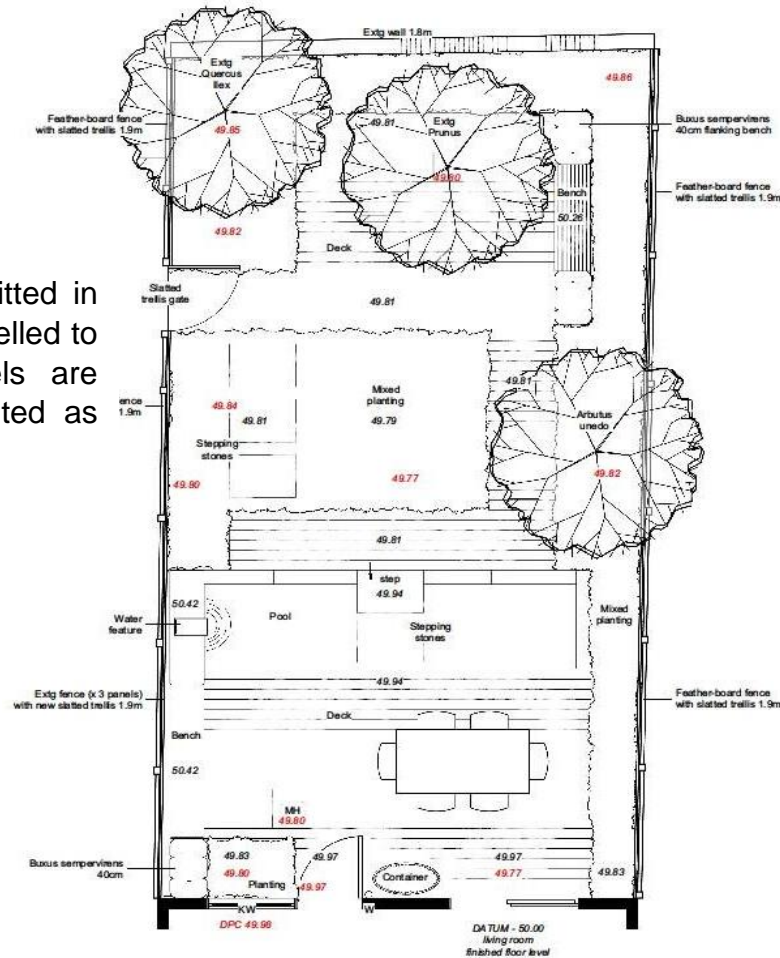

Garden Design Mudchute

INFORMATION

Decking

Ipe smooth boards 145mm
Fixed using Eb-Ty hidden decking fasteners.
www.books4mber.com

Deck cantilevered over pool, finished with 40mm trim
in line with stepping stones.

Stepping stones

Grey yorkstone slabs 900 x 600 x 40mm
www.londonstone.co.uk

Pond edging

Grey yorkstone 230 x random x 40mm
www.londonstone.co.uk

Fencing 1.8m ht

Post & aris rail feather-board fence stained black.

Slatted trellis 1.9m ht

45mm western red cedar slats with 10mm gap
fixed over feather-board fencing.

Gate 1m x 1.9m ht

45mm western red cedar slats with 10mm gap.

Bench - lower terrace

Blockwork uprights with rendered & painted finish
Painted in Farrow & Ball Lamp Room Gray No. 88 or
colour match.
Seat - 150 x 50mm dressed Western Red Cedar
timbers fitted with 20mm WRC spacers. See detail.

Bench - house terrace

Soil blockwork with rendered & painted finish
painted in Farrow & Ball Lamp Room Gray No. 88 or
colour match.
Seat - 3 no ipe deck boards, as above, with 40mm ipe
trim. See detail.

Pool

Blockwork construction with black fibreglass finish
stepping stones & edging as above. See detail.

Water feature

Bespoke stainless steel water shoot set into Yorkstone
coping. Coping bespoke size 40mm thickness.
Painted in Farrow & Ball Lamp Room Gray No. 88 or
colour match. See detail.

Extg wall 1.8m

Painted in Farrow & Ball plummert No. 272 or colour match.

Container

Elipsis 90 planter 90 x 40 x 75cm oak stony slate.
www.urbidesign.co.uk

MH - manhole

Access panel created in decking.

W - waste pipe

KW - kitchen waste pipe

Datum = 50.00 living room finished floor level

Existing levels indicated in red

New levels indicated in black

7. Presentation Plan – example

Hand drawn plan with typed labels and an axonometric drawing for illustration.

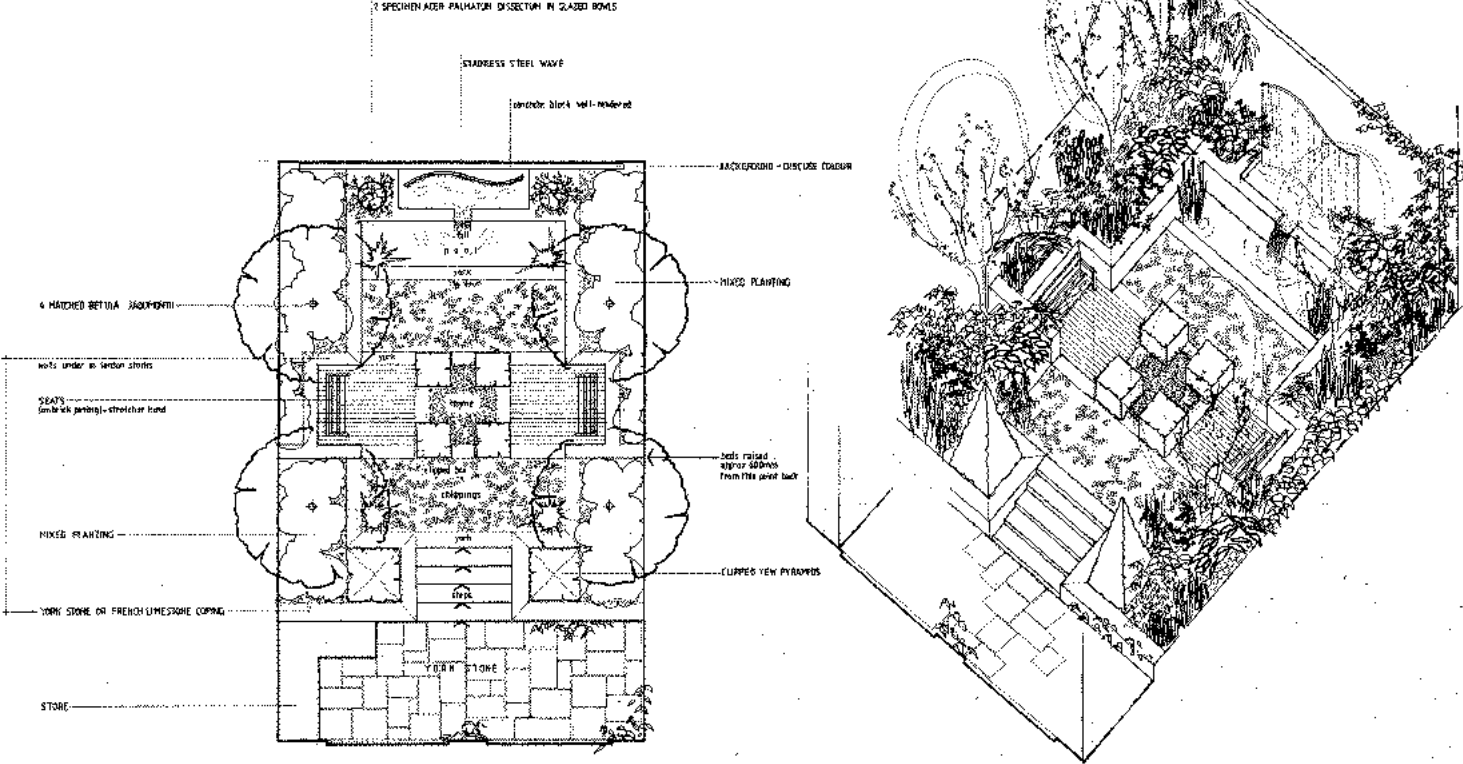

7. Presentation Plan - elevation / section example

A → A: SECTION/ELEVATION - GARDEN LEVELS & OUTBUILDINGS, SCALE 1:100.



7. Presentation Plan - elevation / section example

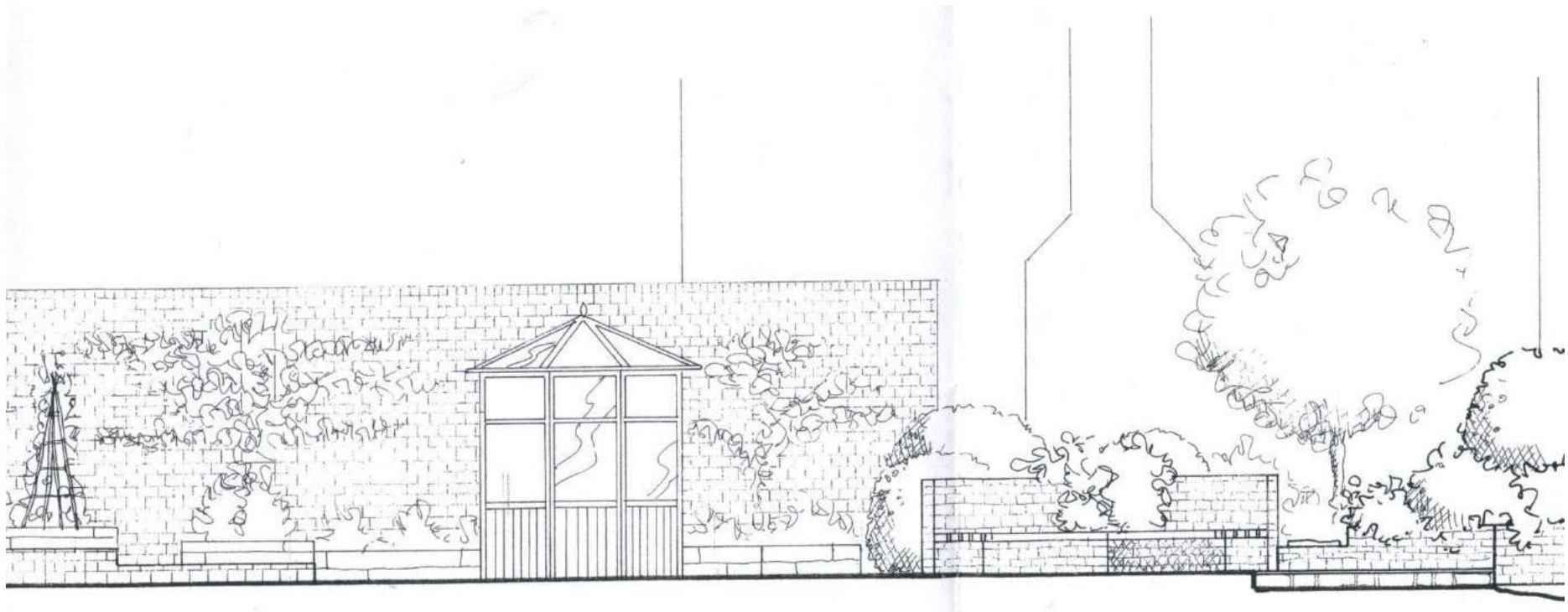

7. Presentation Plan - elevation / section example



7. 3D Supporting Image – example



7. 3D Supporting Image – example



8. Planting Plan(s)

- Clearly labelled with full Latin names
- Show North point, scale and paper size
- Location (where separate plans are provided for each area or bed)
- Appropriate spacings for plants
- Plant densities (where plants are show as large groups rather than individually)
- Plant keys for large schemes and limited palette of plants e.g. Woodland (where conventional symbols or abbreviations are used)
- Repeated patterns
- Overall location plan if borders are submitted separately.

N.B. These are working plans for the contractor to use, so should be clear enough for a person unfamiliar with the site to set out the plants accurately.

8. Planting Plan(s) - example

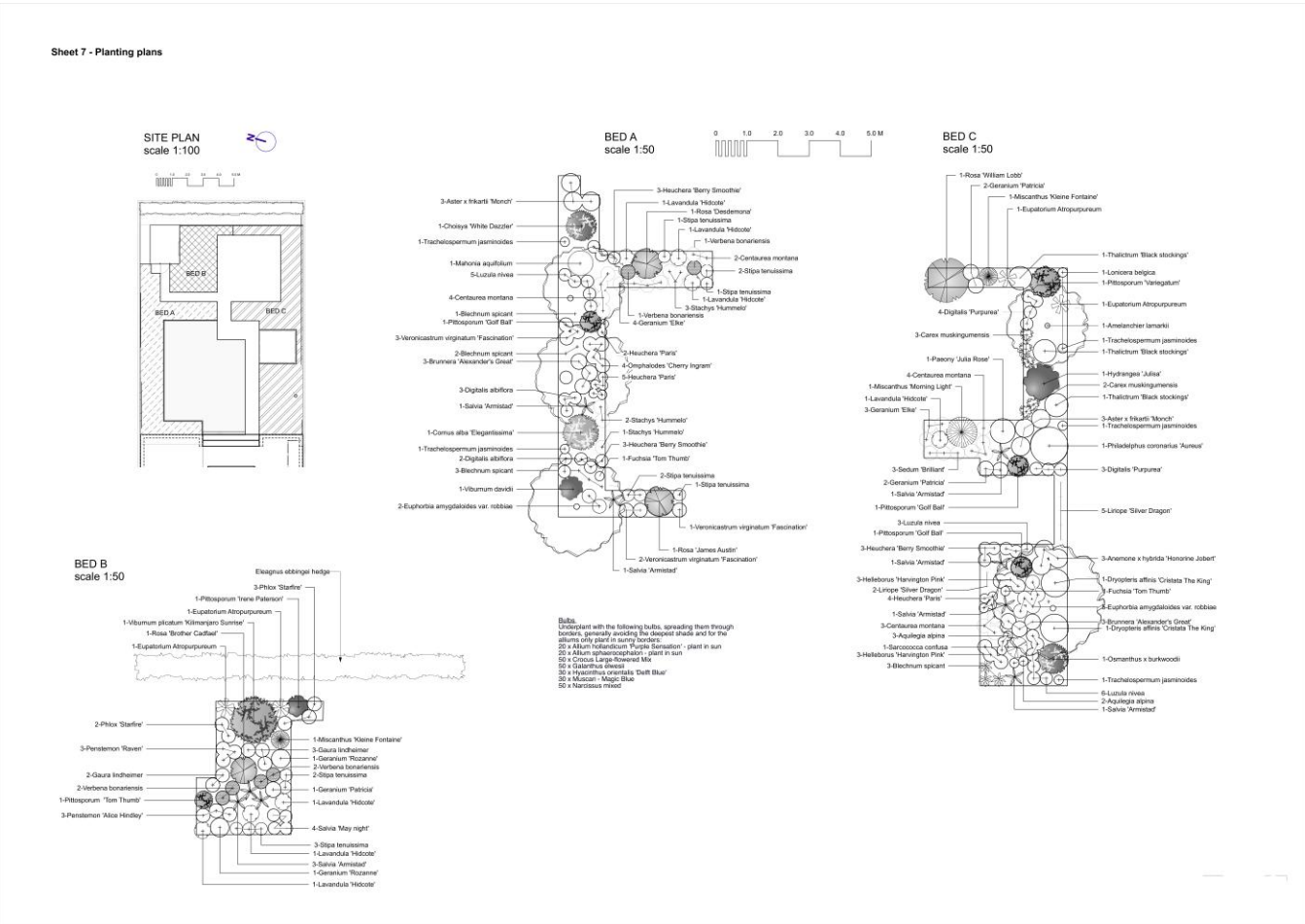

8. Planting Plan – example

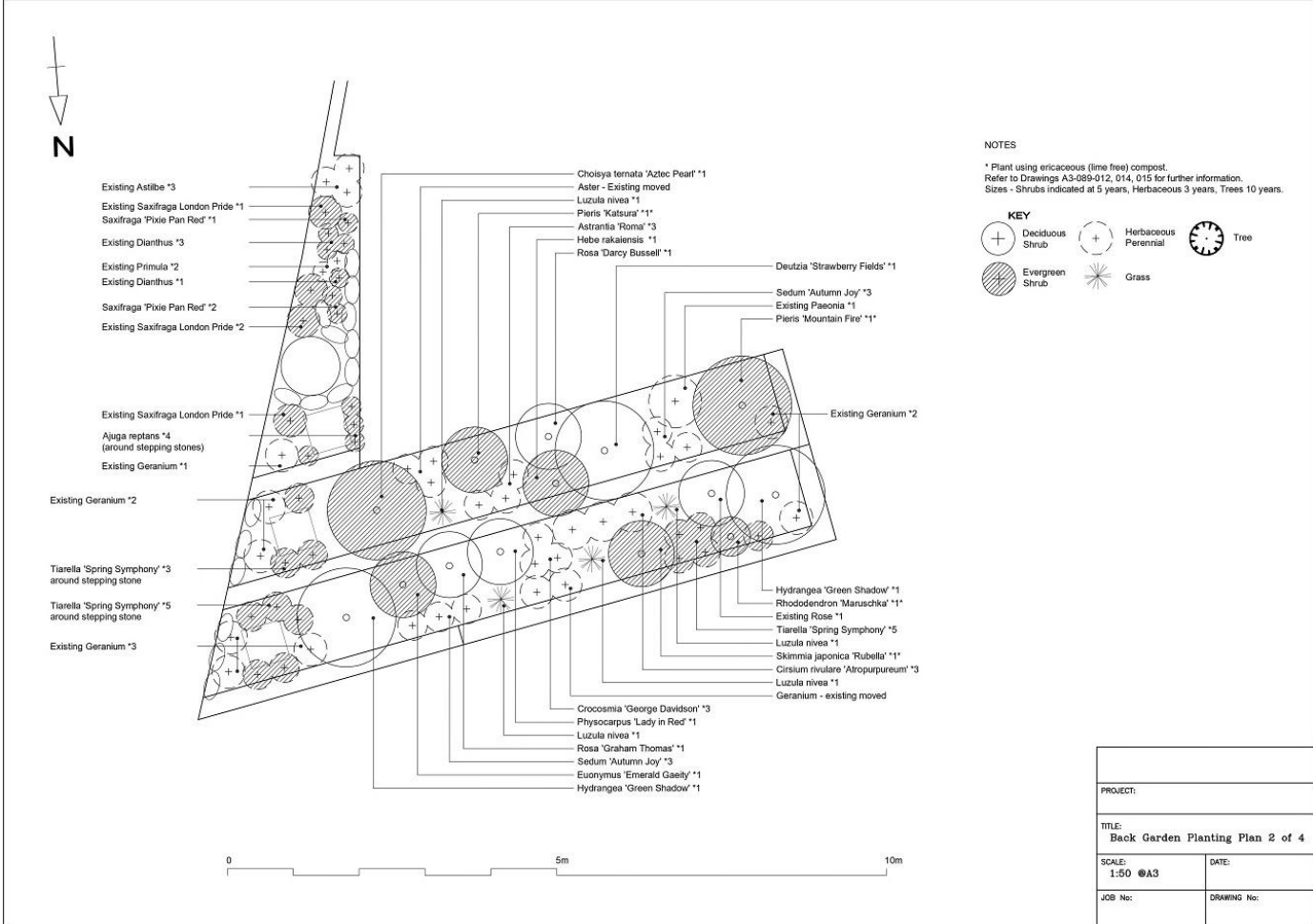

SOCIETY OF
GARDEN +
LANDSCAPE
DESIGNERS

8. Planting Plan – example

Hand drawn planting plan with handwritten labels. No planting centres shown, but numbers of plant in each group are given.

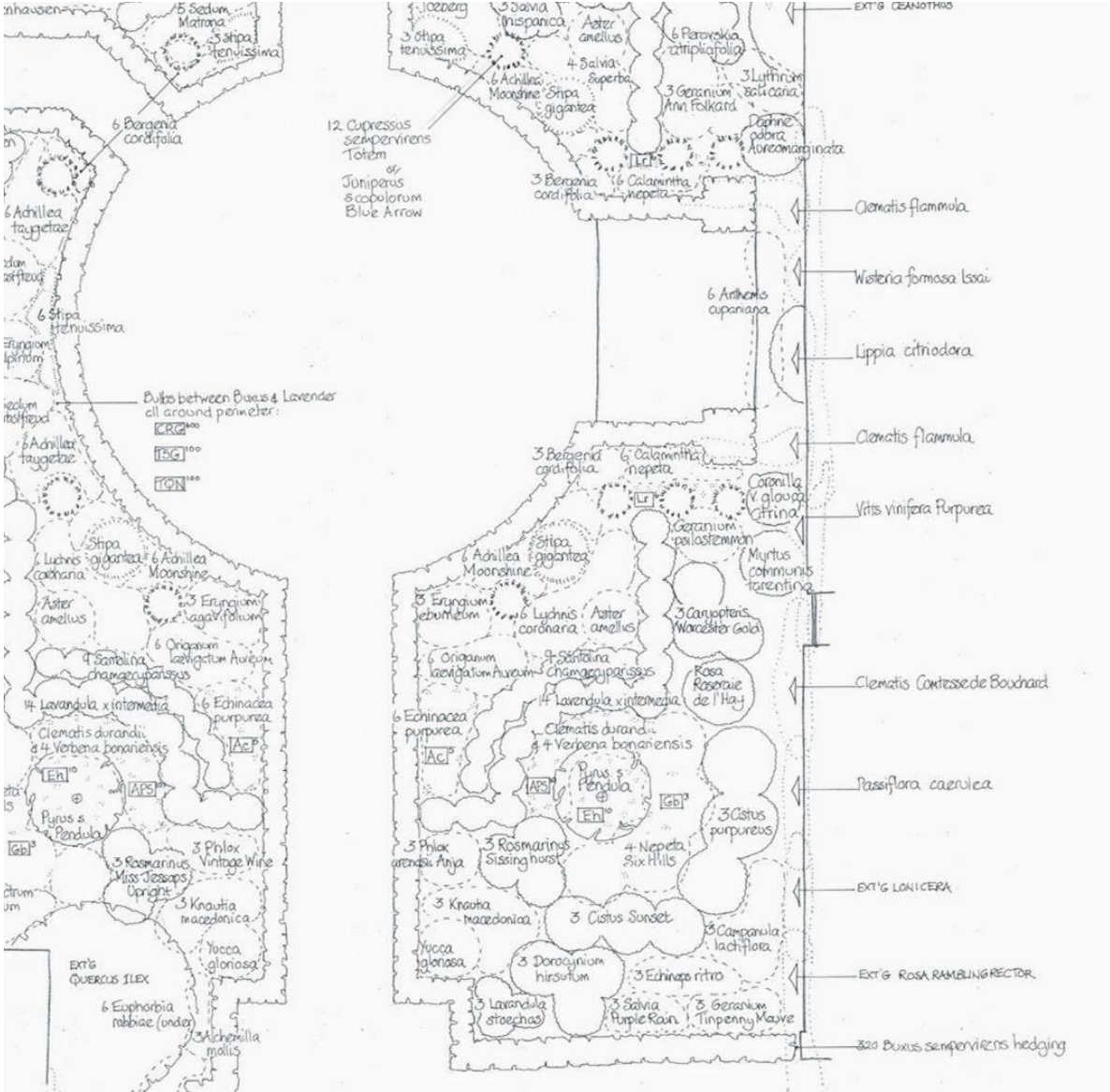

9. Plant Schedule

- Plant quantities
- Genus, species, and variety
- Pot size, bare root, root balled, etc.
- Tree girth, height, e.g., form (clear or multi-stem, standard, etc.)

9. Plant Schedule – example

Plants are divided up into groups and then set out in columns of number, name, and size. A further column for notes could be included if necessary.

PLANT LIST		
Qty	Latin name	Size / Specification
Trees		
2	Apple 'James Grieve'	BR 2yr Half St MM106
3	Apple 'Lord Lambourne'	BR 1yr Half St MM106
3	Betula utilis var. 'Jacquemontii'	50L 3m high multi-stem
3	Amelanchier lamarckii	15L
5	Quercus robur	BR 8/10cm girth
3	Prunus serrula	RB 2.0m clear stem
Shrubs		
1	Abelia grandiflora	10L
3	Caryopteris x cladonensis 'Heavenly Blue'	3L
5	Ceratostigma plumbaginoides	3L
1	Coronilla valentina subsp. glauca 'Citrina'	3L
3	Hydrangea paniculata 'Limelight'	5L
1	Philadelphus 'Virginal'	10L
3	Rosmarinus 'Miss Jessop's Upright'	5L
25	Sarcococca hookeriana humilis	2L
Climbers		
5	Abutilon 'Kentish Belle'	4L
3	Clematis 'Polish Spirit'	4L
3	Rosa 'Gloire de Dijon'	4L
1	Rosa 'Swan Lake'	10L
5	Trachelospermum jasminoides	15L 1.8m high on cane
Herbaceous Perennials		
15	Anemone japonica 'Honorine Jobert'	2L
7	Echinacea purpurea 'Magnus'	2L
5	Mentha spicata	1L
3	Miscanthus gracillimus	3L
5	Origanum vulgare 'Aureum'	1L
7	Rudbeckia maxima	3L
5	Stipa tenuissima	2L
Bulbs		
200	Allium aflatunense 'Purple Sensation'	Top size / Catalogue ref
300	Narcissus cyclamineus 'Jack Snipe'	Top size
300	Narcissus 'Pueblo'	Top size
100	Tulipa 'Spring Green'	Top size

10. One or more setting out plan(s) relevant to the scale & complexity of the project

Depending on the complexity of the project you may want to have this on one plan or more, the suite of plans needs to include the below:

No decisions should be left to the contractor

- Include all dimensions necessary for setting out
- Angles, centres and radii of circles
- Offsets for curves
- Levels and spot heights, original and proposed
- Triangulation, as necessary
- Provisions for surface drainage
- Clear labelling of all design elements

10. Setting Out Plan(s) – example

A simple key makes this drawing easier to understand. All dimensions are given though they are not easy to see on the slide as they are the same colour and weight as the outlines.

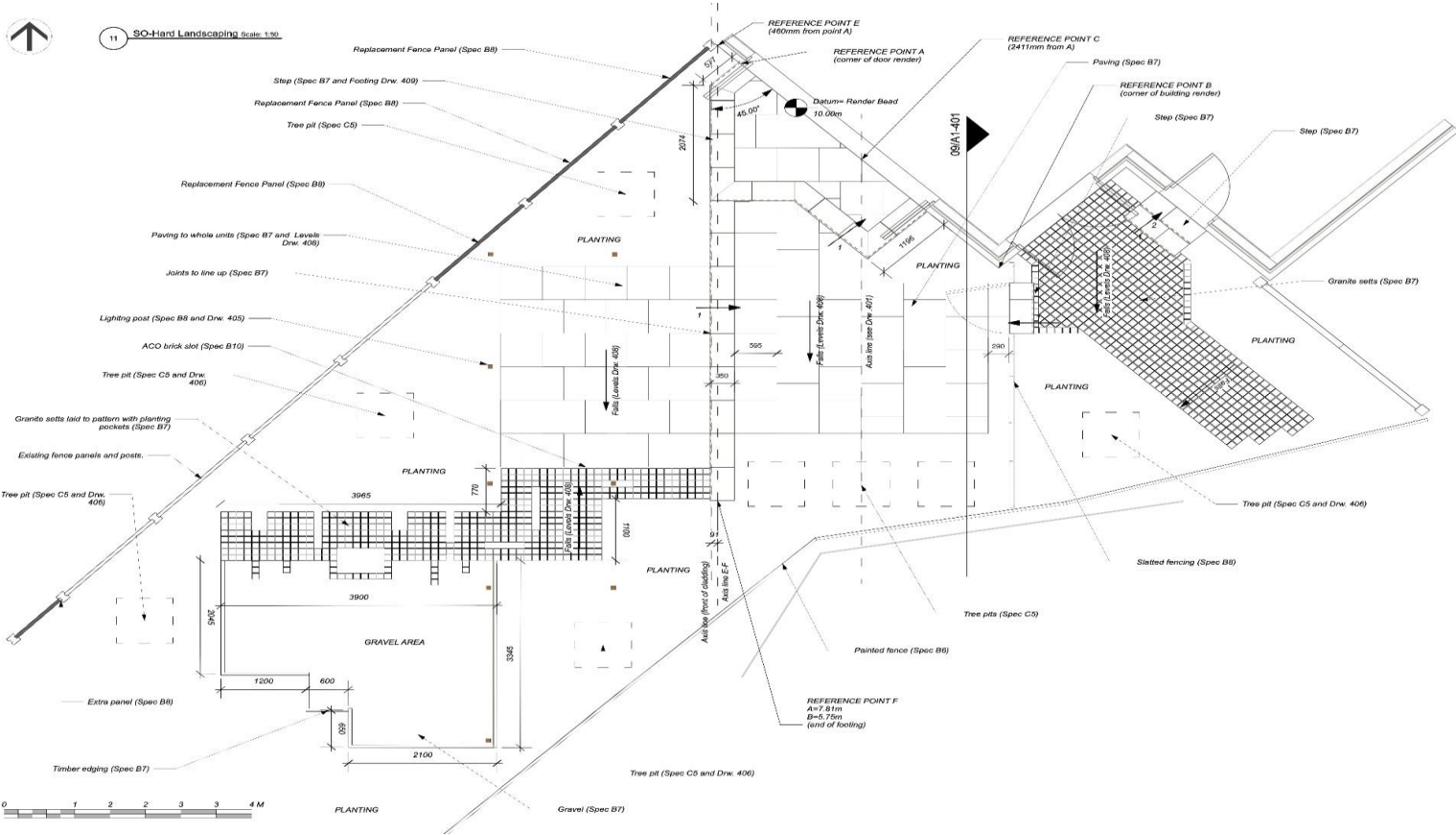

10. Setting Out Plan(s) - example

Circle centres are triangulated from fixed points

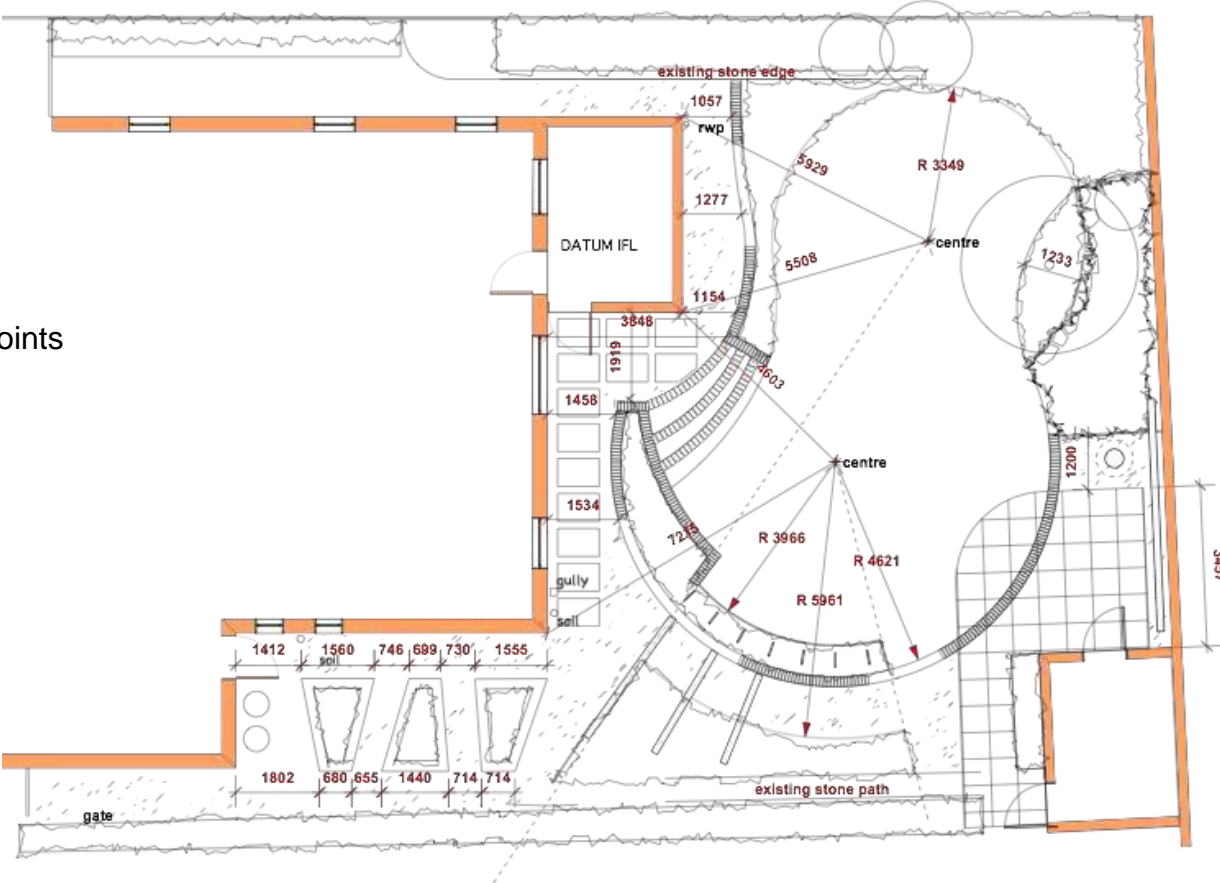

11. Construction Details

- Details for two construction drawings (per project), giving different drawings across all three projects
 - Dimensions
 - Labels
- Cross reference to specification and setting out plan
- Candidates may be questioned on the construction of all three projects

11. Construction Details – example

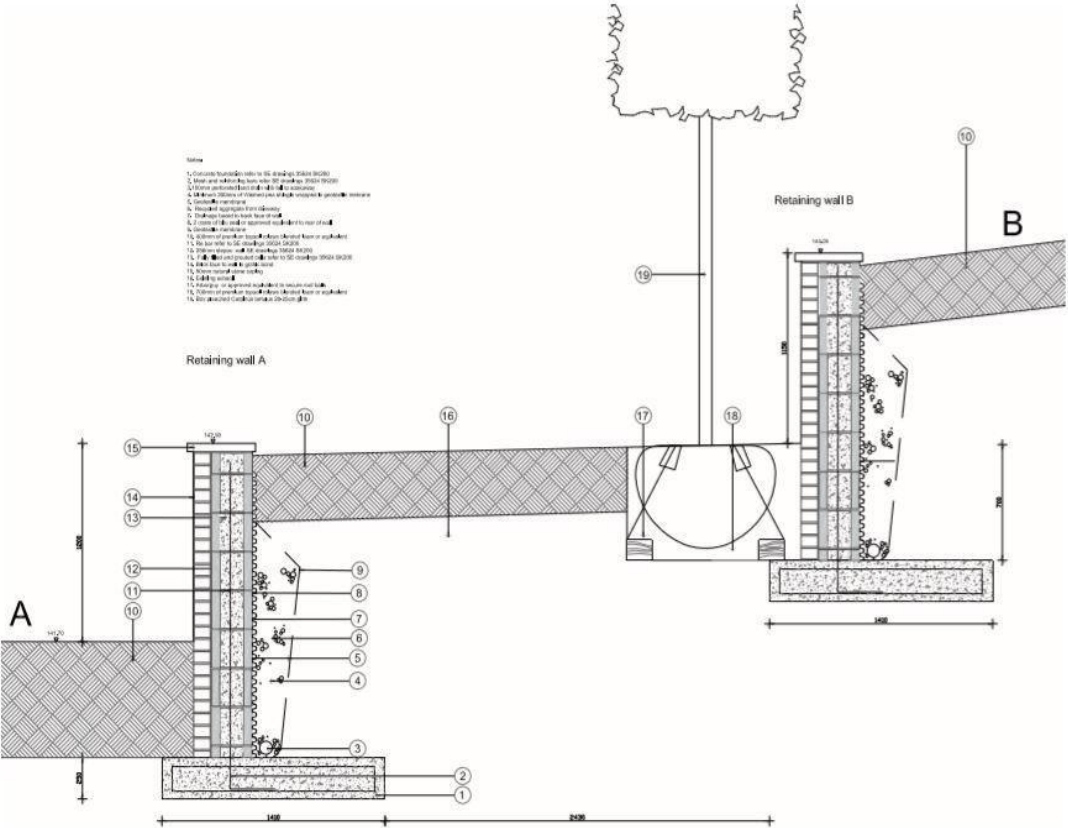

The cross section is by far the most used and the most valuable method of delivering construction detailing as these slices through built forms and underlying ground to reveal foundations, level changes and key dimensions.

Here for example the re-profiled slope and terracing is part of the overall construction information and is delivered with key spot heights for reference.

11. Construction Details - example

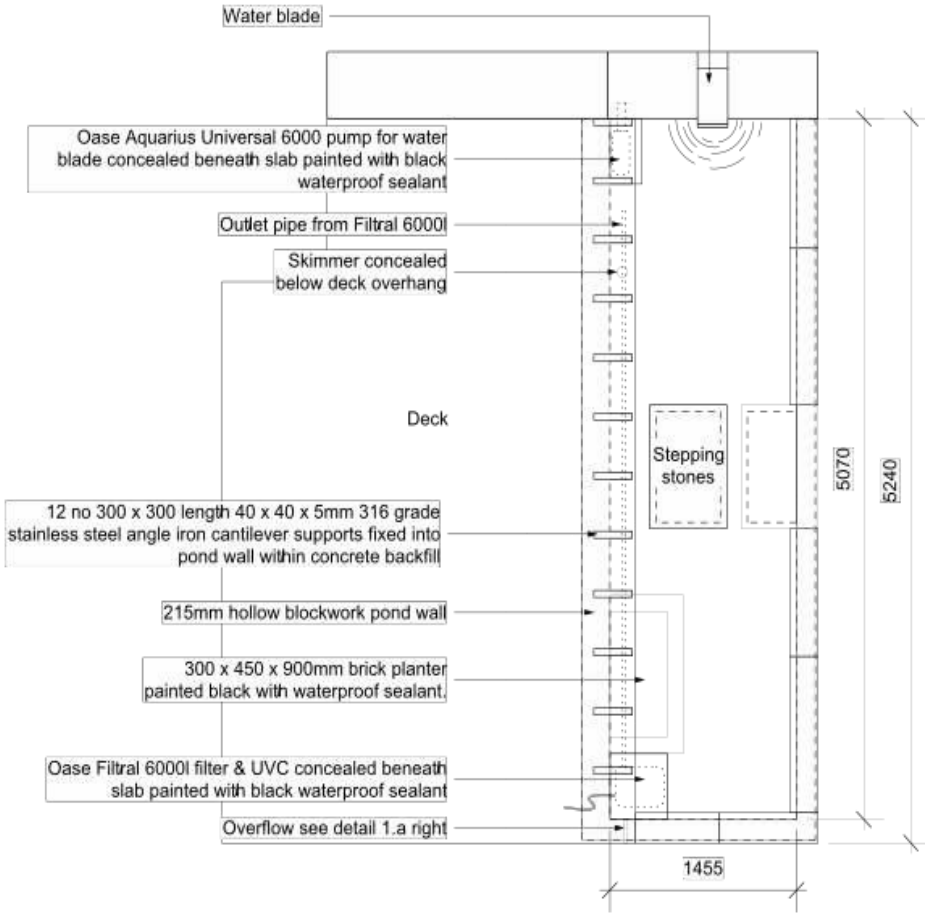

Deck & pool plan 1:50

11. Construction Details - example

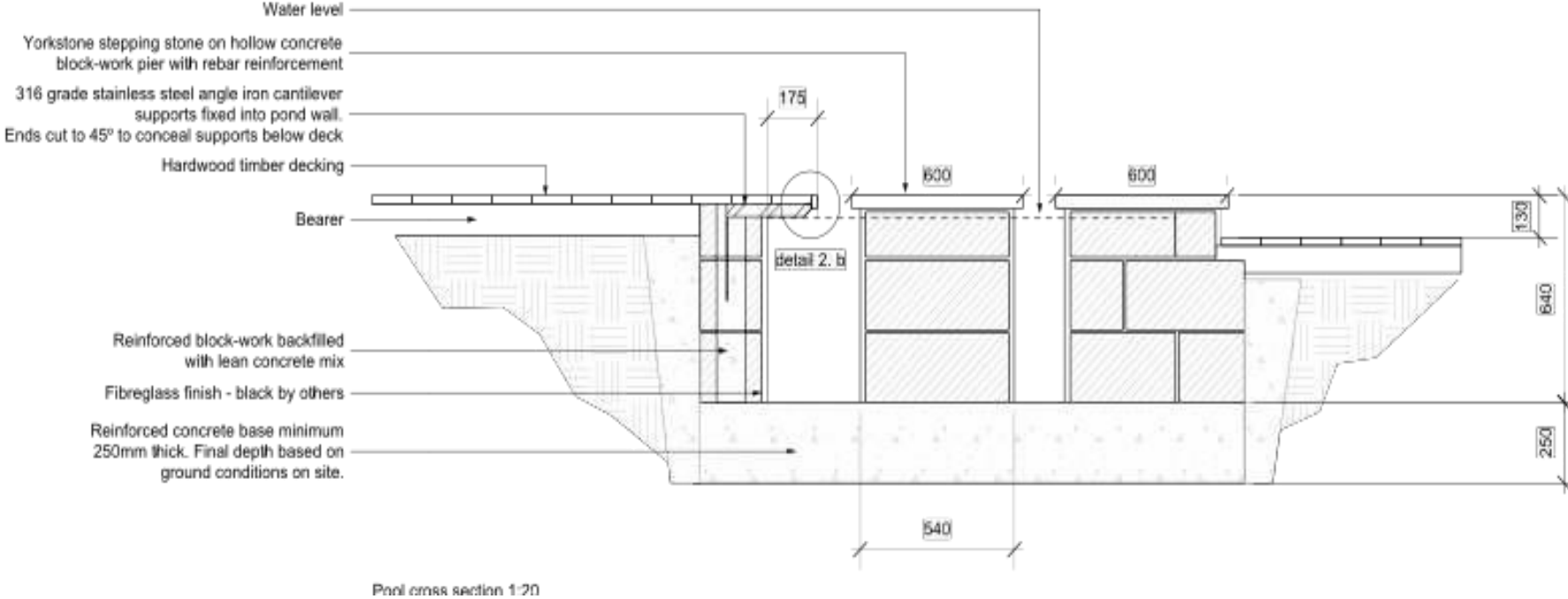

N.B. *Dimensions and careful notes to cover all aspects of construction.*

11. Construction Details - example

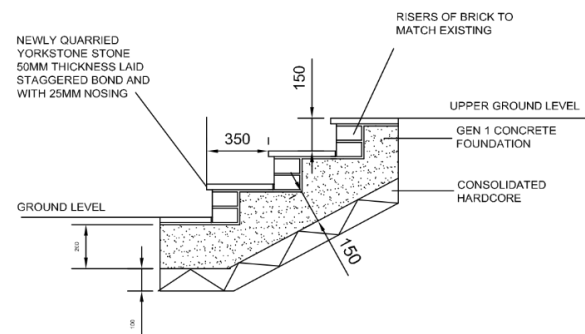
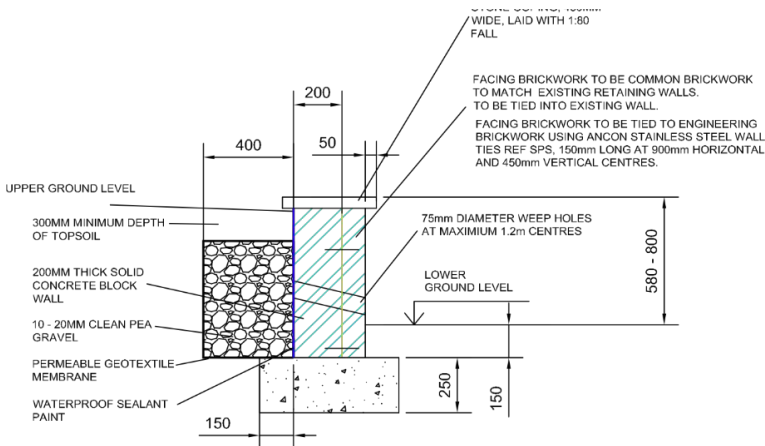

NOTES:

All work to be in accordance with the relevant BS Codes of Practice and the Specification.

All soft areas are to be removed and replaced with concrete having a crushing strength of 10 N/mm²
 Minimum cement content - 275kg/m³
 Aggregate - 20mm

Concrete to foundations to be grade C30 having a minimum crushing strength of 30N/mm² at 28 days.

Minimum cement content to be 275kg/m and to be OPC.

Where wall exposed on both sides, to be brick faced both sides

Bricks
 All bricks to match existing. To be FL and F2 classification. To be approved by client and landscape architect before ordering.

Wall ties
 Facing stone wall to be tied to concrete block work using Ancon stainless steel wall ties, Ref SPS, 150mm long at 900mm horizontal and 450mm vertical centres

Expansion Joints
 10MM WIDE STRAIGHT AND VERTICAL EXPANSION JOINTS TO BE PROVIDED EVERY 5M CENTRES.

STEPS
 TREADS TO BE OF NEWLY QUARRIED YORK STONE LAID TO STAGGERED BOND.
 RISERS TO BE OF BRICK TO MATCH THAT OF BRICK RETAINING WALL AND TO BE AGREED WITH LANDSCAPE ARCHITECT BEFORE COMMENCEMENT ON SITE

SAMPLES OF STONE INTENDED FOR USE TO BE SUBMITTED FOR LANDSCAPE ARCHITECTS AND CLIENTS PRIOR APPROVAL

ALL JOINTS 15MM

11. Construction Details - example

This drawing
cross
references
the specification

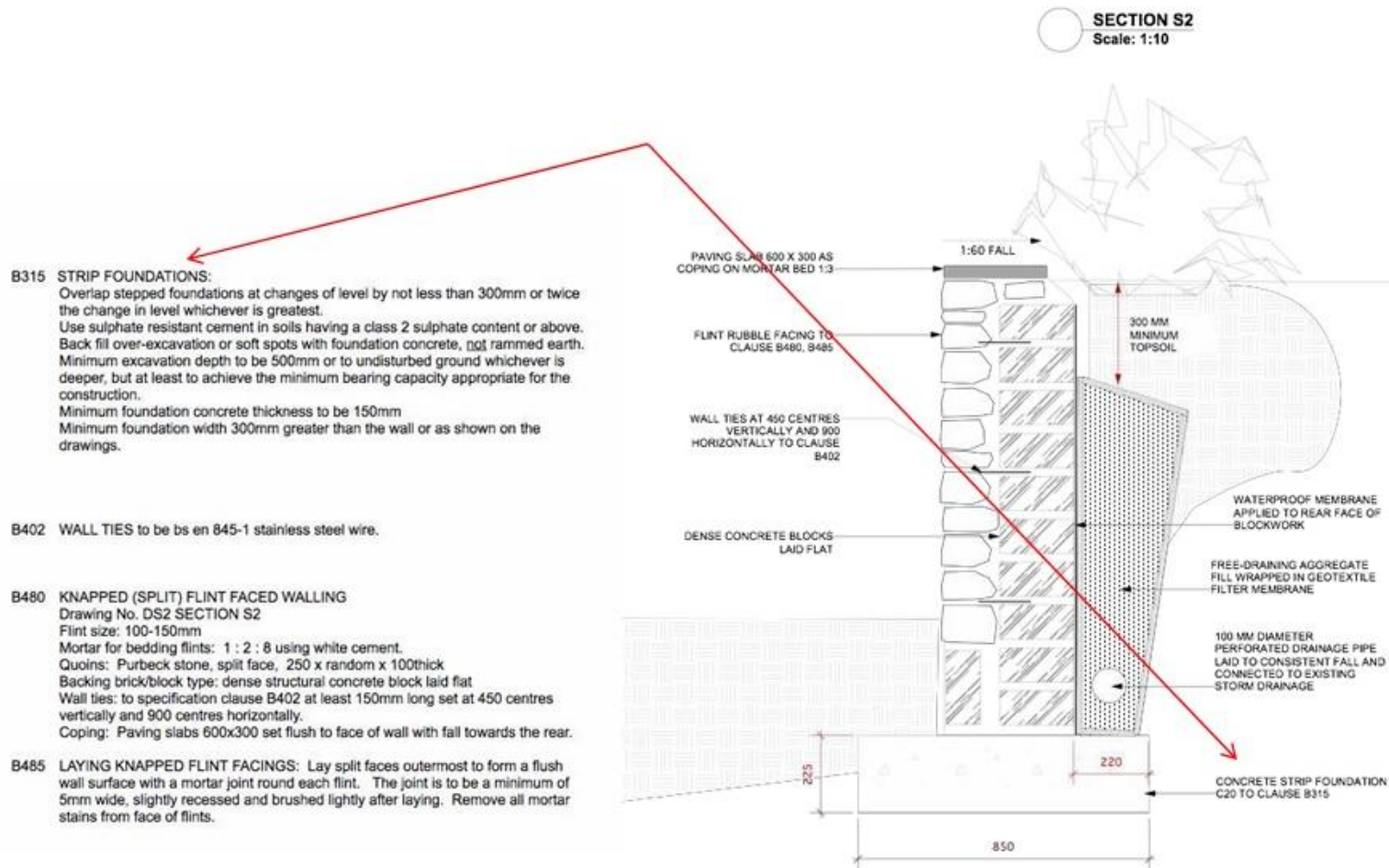

11. Construction Details - example

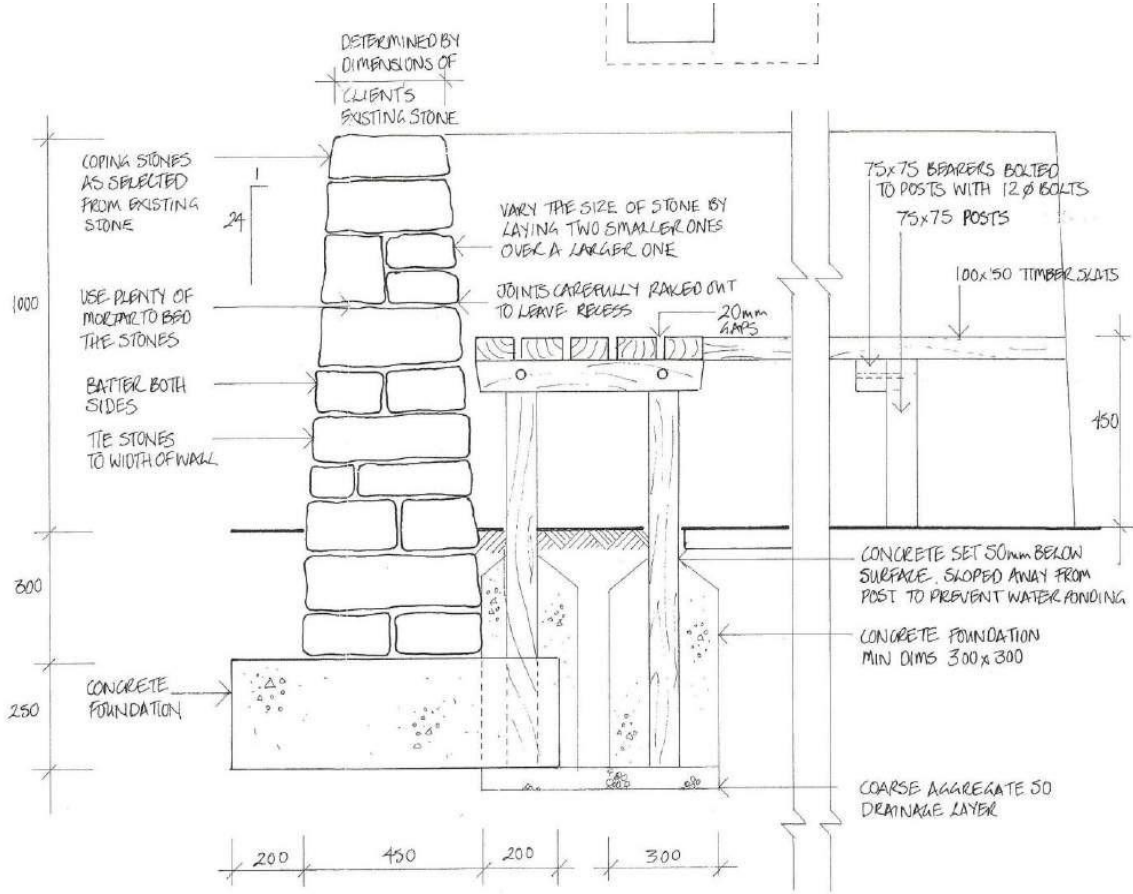

11. Construction Details - example

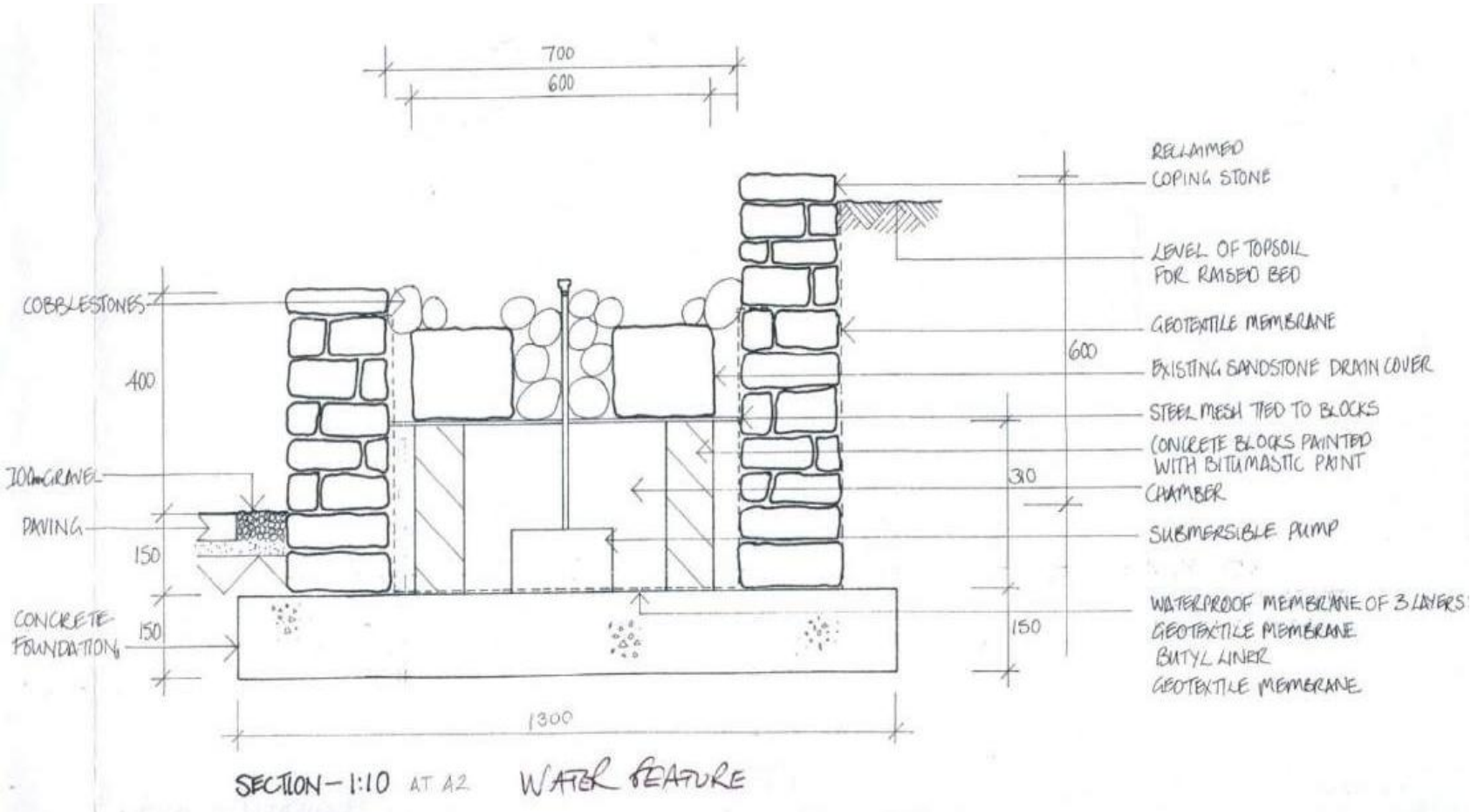

11. Construction Details - example

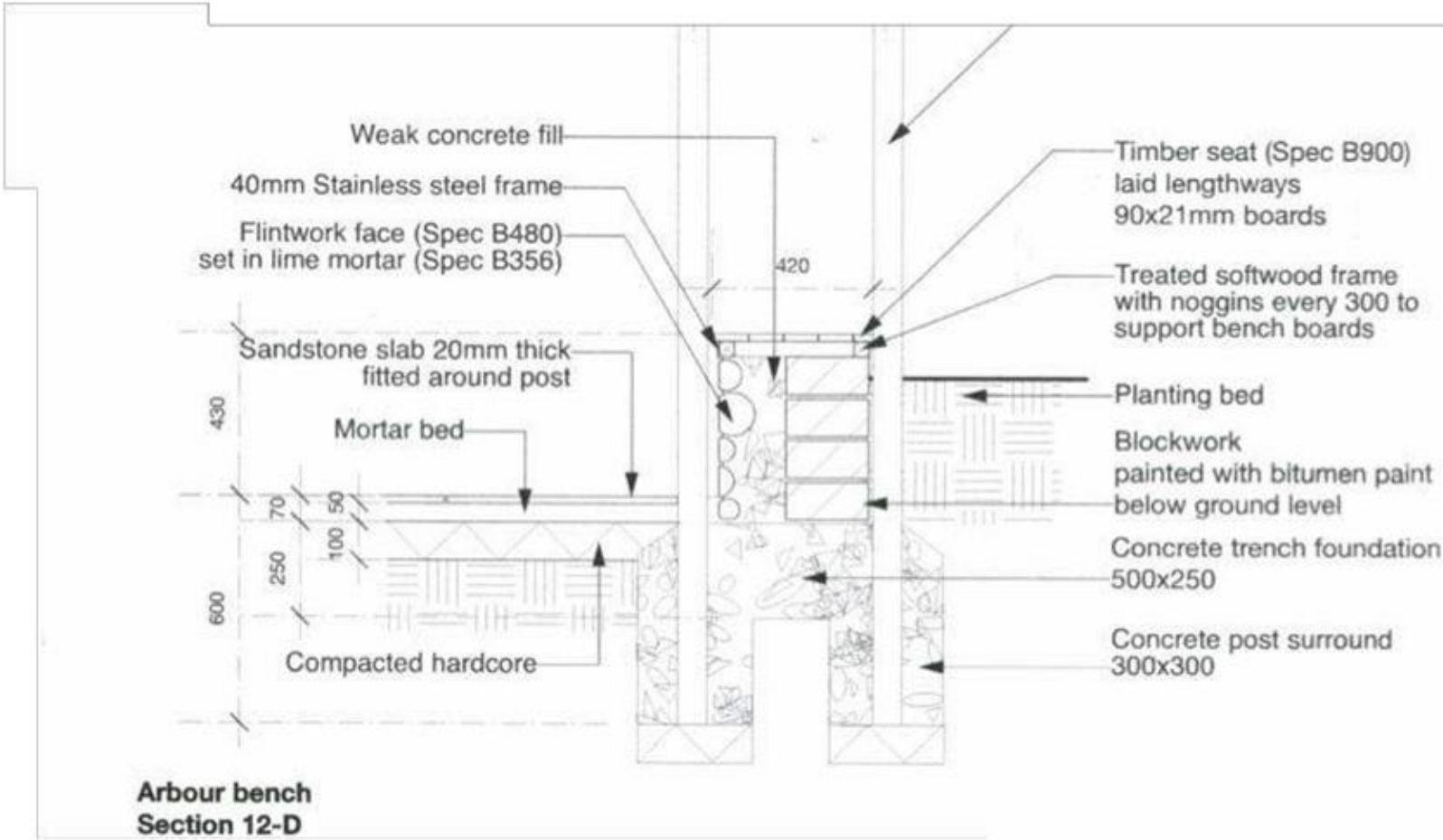

11. Construction Details - example

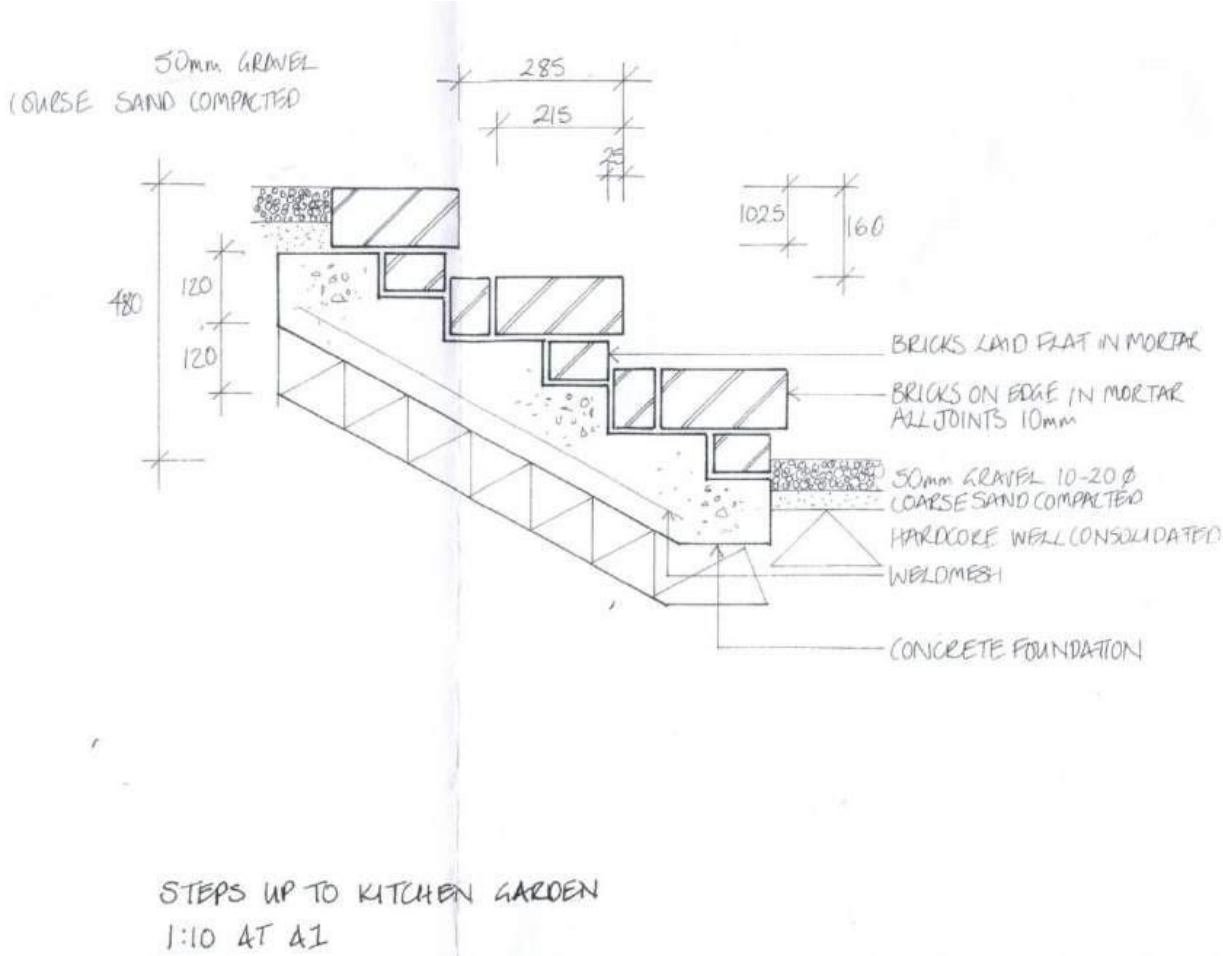

12. Specification & Other Contract Documentation

- The document should be detailed enough for tendering purposes
- The document should be cross-indexed to construction details, setting out plans etc.
- A specification should cover preliminaries such as working conditions, CDM and H&S, hard landscape information not covered by your drawings, details of soft landscaping such as soil preparation, plant quality etc.
- Please use or refer to for guidance the Heather Model for Specifications available from the SGLD

12. Model Specification



Designed to be adapted by designers to suit each of their projects. The specification document is regularly updated with revisions reflecting changes in BS standards or legislation.

Important

When you have completed your project drawings and specification documents ask yourself one important question:

'If I won the lottery tomorrow and went on an extended holiday, could the landscape contractor build the garden and, on my return, would it look as I intended?'

Example Model Specification

A.1. GENERAL PREAMBLE

A.1.1. SETTING OUT: Inform Contract Administrator that setting out is ready for inspection before starting any subsequent construction or planting work.

A.2. EXCAVATION AND FILLING

A.2.1. GROUND WORKS: comply with BS 4428 Code of Practice for general landscape operations and BS 8000-1 clause 3.1 - 3.3 for excavation and filling.

A.2.2. SOIL CONDITIONS: Undertake operations involving topsoil, subsoil in soft landscape areas and subsoil for reuse, when the soil is reasonably dry and workable and non-plastic in consistency, with a soil moisture content at or below the lower plastic limit; not when the soil is wet.

A.2.3. SITE CLEARANCE: remove to an authorised tip all vegetation which is not to be retained, stones larger than 60mm, concrete, brick, tile, metal, timber and any other unwanted material not shown as retained on the drawings or specified for retention or appropriate for reuse in the Works. Segregate materials for recycling whenever appropriate. Advise Contract Administrator before removal or disposal of anything unforeseen discovered.

A.2.4. TREE WORK SUBCONTRACTOR: The removal of major branches or felling of trees over 6m high and similar tree surgery operations shall only be carried out by specialist subcontractors with £1 million (any one claim arising from one event) public liability insurance.

A.2.5. EXISTING TOPSOIL: to be removed from areas of hard landscape and areas to be re-graded.

A.2.6. COMPACTION/DAMAGE BY PLANT:

- Do not allow plant to run over spoil heaps.
- Minimise compaction by controlling access routes.
- Break up all compacted ground or pans in soft landscape areas by subsoil cultivation in accordance with specification clause B2.7 before proceeding with the filling/construction works in the area or before reinstatement.

A.2.7. EXCAVATIONS: Ensure all foundation bottoms have adequate bearing capacity for the proposed Works and keep free of water.

A.2.8. EXCAVATION FOR SOFT LANDSCAPE: Excavate soft landscape areas to accommodate topsoil depths as specification clause B.2.10, as necessary and store sub-soil for reuse or remove from site as appropriate.

A.2.9. SUBSOIL CULTIVATE: Break up subsoil with appropriate machinery for soil type and in appropriate weather and soil conditions to a minimum depth of 300mm.

A.2.10. SUB-SOIL: Store clear of topsoil in separate heaps. Soil in excess of requirements or deemed unsuitable for back-filling, to be removed from site.

A.2.11. SPREAD TOP SOIL from topsoil storage heap / imported to provide the following requirements and minimum depths:

- shrub areas 400mm;
- Graded slopes to be of even gradient
- Graded to avoid ponding hollows;
- Graded to even flowing contours with no sharp angles in any direction;
- Topsoil edges 50mm above bordering hard surfaces to allow for settlement.

SOCIETY OF GARDEN + LANDSCAPE DESIGNERS

A.2.12. Imported topsoil to be:

- Multipurpose natural (not manufactured) topsoil;
- Criteria: Meet BS3882:2015
- Stone size to pass a 40mm sieve and stone content (over 2mm) to be less than 20%;
- Free of building materials or other similar alien matter, sub-soil, large roots, stolons, rhizomes or poisonous substances;
- Submit details of source of topsoil

A.2.13. FILL TO HARD LANDSCAPE AREAS

- Ensure starting surface is of appropriate material and compaction.
- Add appropriate material and compact in layers maximum 200mm thick to achieve adequate bearing for foundation of proposed finish material and allowing for depth of construction.
- Remove inadequate materials and fill with appropriate material and compact.

A.2.14. GRANULAR SUB-BASE: Granular sub-base: to be Type 1 MOT material, minimum 100mm thick. Compact sub-base with a compactor plate to achieve a smooth closed surface.

A.3. CONCRETE AND MORTAR

A.3.1. CONCRETING IN COLD WEATHER

- Do not use frozen materials;
- Do not lay against frozen formwork or frozen excavations;
- Do not do concrete or mortar work in temperatures of 4oC and ensure temperatures are not forecast to fall below 4oC for at least 3 days.

A.3.2. CONCRETE CURING: Protect from frost, snow, wind or hot sun by covering all concrete with polythene sheet for a minimum of 7 days. Do not allow any wheeled traffic on concrete bases or drives for at least 14 days.

A.3.3. MIXING AND PLACING CONCRETE

- Use appropriate batch mixer.
- Provide adequate appropriate formwork if necessary.
- Place as soon as practical after mixing and before the initial set takes place.
- Compact thoroughly and achieve a level top surface after compaction or even falls as shown on the drawings

A.3.4. MATERIAL FOR MORTAR

- Cement: CEM I class 42.5N to BS EN 197-1
- Lime: to BS EN 459-1
- Sand: soft building sand to BS EN 12620
- Store lime and cement in a ventilated dry store clear of the ground.
- Mortar plasticisers where specified to be of the air entraining type to BS EN 934-3, and use according to the manufacturer's recommendations.

A.3.5. MAKING MORTAR

- Batch mortar proportions by volume using gauge boxes.
- In cold weather pre-heat water and sand.
- Do not mix for longer than 5 minutes after adding water.

ELEMENTS

For setting out of design, see Drawings 03-01 to 03-04.

SOCIETY OF GARDEN + LANDSCAPE DESIGNERS

A.4. RAMP AND STEP

A.4.1. For Ramp and step, see Drawing 19D006/04-01

A.4.2. Balustrade

- To be provided by metal fabricator
- Fixing, as per Drawing 19D006/04-02

A.4.3. Ramp Up-stand - see Drawing 19D006/04-02

A.5. PATH 1, PATH 2 AND PATIO 1

• For layout and paving pattern for Paths 1 and 2 and Patio 1, see Drawing 19D006/03-03.

• Sub-base

- Geotextile separating layer to be laid over excavation

- Granular sub-base: minimum 100 mm thick Type 1 to Specification B2.14.

• Surface = Paver A: CED Stone, Beige Sandstone, Riven

- Sizes: as per Drawing 03-03.

- Bed pavers with slurry backing applied on a continuous 50 mm semi-dry C7-C10 concrete (1 cement: 2 sharp sand: 6 gravel). Ensure pavers are at specified level +/- 6mm and free from rocking and that the difference in level of adjacent pavers is less than 4 mm.

• Joints: Flush, 10 mm pointed with CED Stone buff jointing compound or equivalent to manufacturer's instructions

A.6. PERGOLA

• As per Drawing 19D006/04-03.

• All timber to be FSC pressure treated pine, rough sawn, lightly sanded. Specification minimum C16 UC4

• Metal fixings all to be galvanised or rust resistant finish equivalent.

13. Management and Development Plan with Sustainability Statement (for third submission only)

A separate Management and Development Plan, with a Sustainability Statement, will be required for the third project only. This should:

- Describe how and by whom the completed garden will be managed, maintained and developed. What are the seasonal requirements to maintain the scheme.
- Include examples of any maintenance instructions and requirements seasonally for hard landscape elements and planting
- State how the project has impacted the environment of the site. Describe interventions that have mitigated or improved the garden environment:

SOCIETY OF GARDEN + LANDSCAPE DESIGNERS

Points to consider or include where possible and applicable:

- Criteria for material and product selection in design – Footprint, durability and sourcing
- Careful soil management and protection with minimum hard footprint
- Tree protection, wildlife corridors, diversity of habitats
- Selection of plants to enhance local ecology with low input requirements
- Biosecurity considerations
- Adoption of Sustainable Drainage Systems (SuDs) and efficient on-site water management such as rain water harvesting systems
- Avoidance of Pesticides and Herbicides on site
- Recycling of materials on site
- Ethical Sources for materials and plants
- Travel efficiencies to site of labour and materials
- Recycling and reduction in packaging and waste
- Responsible disposal of hazardous materials and waste
- On site compost facilities
- Low energy and low carbon footprint considered
- Sustainable design that can be managed with low energy inputs for future

14. CDM (for third submission only)

As part of the accreditation process, the SGLD asks that your CDM documentation is submitted for your third project (submission for first and second project recommended).

- The CDM regulations apply to all construction projects including landscape, no matter how long (or short), or if you are working on a commercial project or in someone's home. If you do any construction work, CDM applies and you as the principal designer (for 3rd project please complete this element as though you are the principal designer) (The role of the principle designer on a project is to help and advise the client, the design and the construction teams in bringing together the design, pre-construction and during construction information relative to the health and safety risks of the landscape on the project. This will be an ongoing process keeping all involved informed of any risks as the project develops and those that may need to be controlled during the construction process. The data will form part of the project H&S file.) The principal designer maybe you as the garden designer or alternatively could be another lead consultant such as the architect) and you therefore have a legal obligation to undertake CDM regulations and fulfil your duties.

Whatever your CDM role, you need to make sure that the client is aware of their duties under CDM Regulations, and ensure that the project is notified, if necessary. The CDM documents you create for your project should be proportionate to the project.

The pre-construction information document is required on every construction project. No matter how big, small, short or long. It is the first CDM document to be produced, as it is required before work starts on site, developed during the design stages of the project.

During the construction phase, the hazards present on the site will need to be recorded and addressed, along with arrangements for managing health and safety during the project. You might not know all your plans from the start, of course, as things can change during the project. So you can revise and add information to the construction phase plan document as you progress through the project, each revision should be recorded.

SOCIETY OF GARDEN + LANDSCAPE DESIGNERS

As the principal designer, it is your duty to start preparing the health and safety file during the pre-construction phase. The file will then be developed throughout the project and handed over to the client/contractor on completion.

The SGLD have produced a template (found on the SGLD web site) which can be followed to record the process. Alternatively, you can develop your own, or use one provided by the project team. Any format can be submitted as long as it meets the requirements.

[Link to CDM Guidance and Templates](#) found on SGLD Website, Resource Area – chose CDM from the dropdown menu.

15. Photographic Record

- Include a range of shots to show the site before, during and after construction.
- Shots should be taken from the main viewpoints and show construction details.
- Shots should be taken during constructions on projects that have been monitored.
- A range of views showing garden on completion and after planting.

15. Photographs – examples

SOCIETY OF
GARDEN +
LANDSCAPE
DESIGNERS

Project A 'Before' shots showing all sides of the garden.



2A – view to rear boundary



1A - View to house



3A – view to west boundary

15. Photographs - examples

Project A 'after' shots of the same areas of the garden



15. Photographs - examples

View 1A



View 1C

Summary

- The Accreditation Process information for candidates and the Code of Practice are available to download from the SGLD website.
- The Accreditation fee is included as part of the pre-Registered annual membership.
- Plan for your accreditation. Do all the drawings and documents for current and upcoming projects.
- Take your work along to an accreditation advice session to obtain some instant feedback from a member of the panel.
- If the accreditation days are showing 'full' on the website, ask to be placed on a waiting list and we will put on another panel as soon as we have enough entries.
- The SGLD is here to help you achieve a professional standard of work.

Final Checklist

1. CV (only submit once if doing a single submission)
2. Agreed Client Brief
3. Client-Designer Contract Documentation
4. Site Survey
5. Site Analysis
6. Design Rationale
7. Presentation Plan, Cross-section, suitable to be submitted to the client
8. Planting Plan(s)
9. Plant Schedule
10. Setting Out Plan(s)
11. Construction Details – *a minimum of two of the most significant features*
12. Specification document to contractor
13. Management & Development Plan with Sustainability Statement **(for third project only)**
14. CDM Risk Assessment **(for third project only)**
15. Photographic Record